



**Cole Hersee**<sup>®</sup>  
A Littelfuse<sup>®</sup> Brand



**Manufacturing switches since 1924**

[colehersee.com.au](http://colehersee.com.au)



## History - Manufacturing switches since 1924

Cole Hersee has been designing and manufacturing reliable electrical switches for vehicles for over 90 years and have been recognised for innovative products throughout their history.

As the original designer and patent holder, Cole Hersee switches and connectors made today are specified by OEMs and used as high-quality replacement parts.

Although 1924 is taken as the date Cole Hersee was established, antecedents go back even further to the dawn of the automobile age: The Henry Cole Company of Boston was founded in 1914!

Cole Hersee are a leading manufacturer of electromechanical, electronic & digital switches and connectors, designing dependable products for a broad range of vehicles.

Since its founding in 1924, Cole Hersee has been a pioneer and leader in the development of heavy-duty electrical products for the vehicle industry, earning a reputation for quality and value.

Cole Hersee collaborated on many basic industry standards and today is a preferred supplier of over 2,000 dependable vehicle products and accessories. Cole Hersee is ISO 9001:2008 certified.

Cole Hersee was acquired by Littelfuse, Inc. in 2010.

## Partnership - Cole Hersee is proudly supplied across Australia and New Zealand by ESG Asia Pacific

ESG Asia Pacific are currently, and have been, the exclusive Australian and New Zealand distributor of Cole Hersee for over 20 years.

## Brands of ECCO Safety Group



### It's not how much you save, it's what and who you save

What would happen if you couldn't shut off the power in an emergency?  
What would happen if the power was accidentally switched on while someone was working on a machine? What would happen if you couldn't securely lock off your machinery—only to have it then damaged, vandalised, or stolen?

### Beware of inferior and copy products

Cheap copy components can cause expensive damage to equipment and put lives at risk. Cole Hersee products are renowned for quality and reliability that will protect you, your workers, and your valuable vehicles and equipment.





# GENUINE COLE HERSEE

## 75910 BATTERY MASTER SWITCH

**Cole Hersee 75910 Battery Master Switches are designed and built to not only withstand harsh mining environments, but also to ensure that when the switch is on or off, it stays on or off—without any chance of it being accidentally switched or deliberately tampered with.**

This battery master switch was developed by ESG Asia Pacific in conjunction with Cole Hersee and major mining corporations, to service specific safety requirements.

The 75910 has an extended actuation point to prevent accidental actuation even when a lockout lever is in use.

For more features and specifications on this switch please see page 9.

*Cole Hersee 75904 with a standard 4° actuation point*

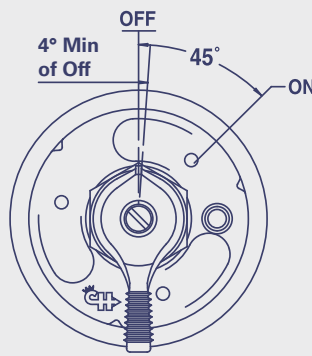

*Cole Hersee 75910 with an extended 17° actuation point*

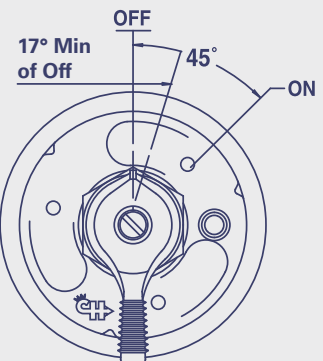

## Battery Master Switches

Page 8

For over 40 years Cole Hersee has been designing and building heavy duty Battery Master Switches that have been installed as OEM equipment by leading manufacturers of heavy duty vehicles.

Battery Master Switches shut down a vehicle's electrical system by cutting off current from the battery. They are designed to help prevent tampering, theft, battery drain and electrical fires.

Battery Master Switches are available with brass or plated steel cases and are actuated by lever or hencol key. Contacts are either silver or copper. O-rings feature in the operating shaft of some models for additional moisture and dirt protection.



## Rocker & Toggle Switches

Page 18

Rocker & Toggle Switches are manufactured in many different variations to handle most vehicle and equipment applications and are usually classified by the number of poles and throws to identify their basic operation.

Cole Hersee Toggle Switches are available with ball, short or long handles, paddle or illuminated actuators. Housings are either plastic, plastic and metal combined, or die-cast metal.

Rocker Switches can be either snap-in or bracket mounting, actuators can be illuminated or imprinted, contain pilot lights, or have both pilot lights and imprinting.



## Push Button Switches

Page 40

Push Button Switches (sometimes referred to as momentary switches) are most commonly used for Off/Mom On ignition type applications.

Cole Hersee Push Button Switches are available in die-cast alloy or brass housing with most featuring chrome plated button and face nut or rubber capping.



## Rotary Switches

Page 44

Rotary Switches are usually used for special purpose applications including headlamp and windscreen wiper operation. The Cole Hersee range features models which can be used for more common applications.

Cole Hersee Rotary Switches are available in die-cast alloy or nylon housing with most featuring a nylon knob to fit in with your existing vehicle interior.



## Ignition Switches

Page 48

Ignition Switches are operated by a coded key and tumbler lock, hencol keyed lock or lever. Lever design is available in three different configurations: short, long and military. Ignition Switches are available with coded cylinder locks and keys or hencol non-tumbler locks with compatible keys.

Switches are available with a grounded case design with a separate ground terminal. A grounded case switch must be installed in a metal panel which is part of the vehicle earthing system.



## Solenoids

Page 52

A Solenoid is an electromagnetic relay used in a direct current wiring system between a low current capacity switch and a high current load requirement.

In an engine starting system, the Ignition Switch in the start position may have a rating of 5 amps whilst the starter motor may have a cranking requirement of 200 to 350 amps.

Once energised by the Ignition Switch, the Solenoid coil moves the high current capacity contact to a closed position, thereby energising the starter motor.



## Circuit Breakers

Page 62

Cole Hersee Circuit Breakers are designed and engineered for responsive performance over a long period. Casings are manufactured from either high quality plated steel or durable plastic.

Cole Hersee Circuit Breakers are designed and engineered for responsive performance over a long product life.

All Cole Hersee Circuit Breakers conform to SAE Standard J553.



## Connectors and Electrical

Page 66

The Cole Hersee range includes high quality connectors and electrical equipment such as heavy duty trailer connectors, battery studs & jumpers, headlight connectors and electronic units.

Cole Hersee trailer connectors are built to withstand the rigors of trucking thousands of kilometres in dust and dirt, heat and cold, yet maintain the all-important electrical continuity between vehicle and trailer.





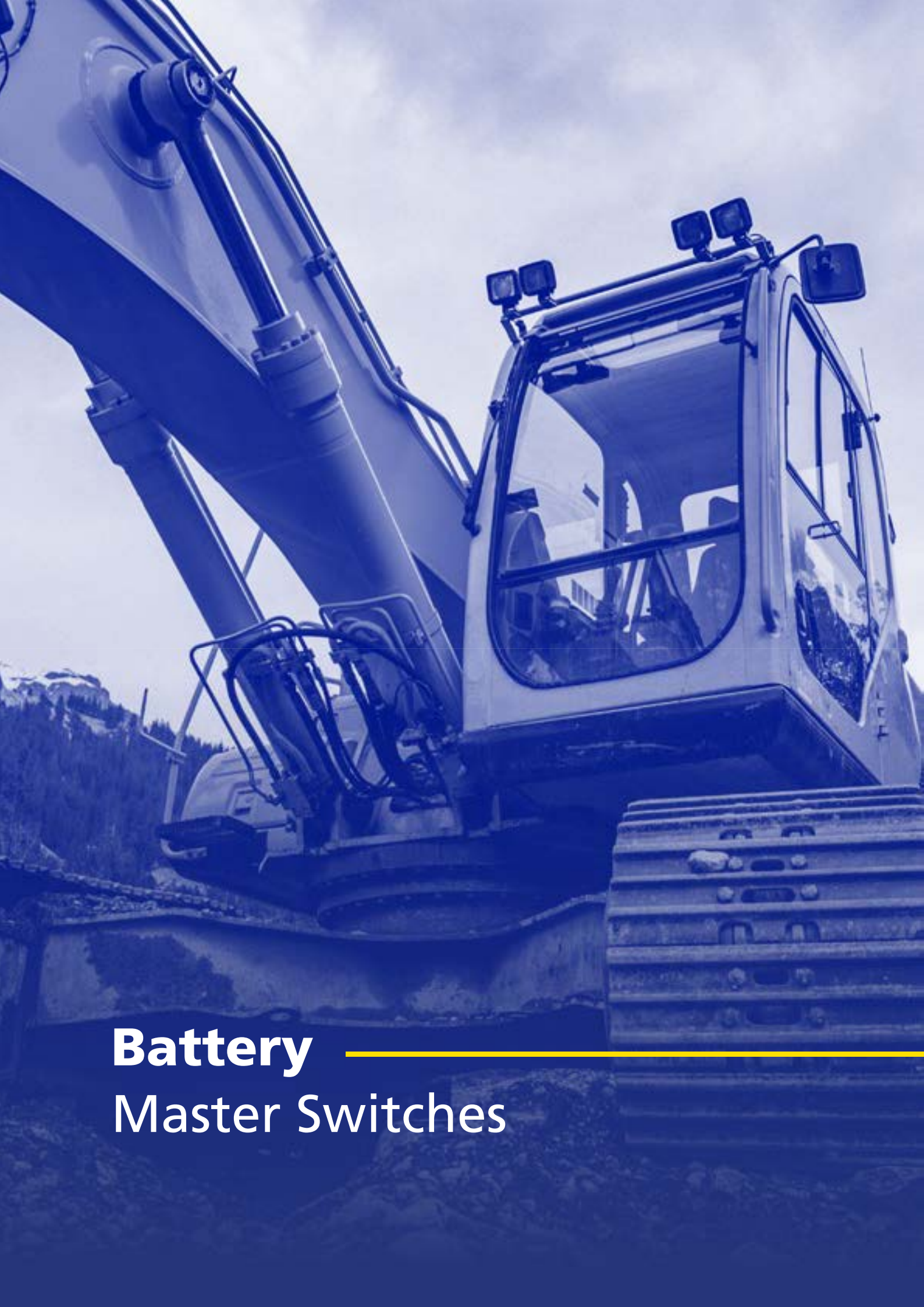

# Battery

---

## Master Switches



# BATTERY MASTER SWITCHES

For over 40 years Cole Hersee has been designing and building heavy duty Battery Master Switches that have been installed as OEM equipment by leading manufacturers of heavy duty vehicles.

Battery Master Switches shut down a vehicle's electrical system by cutting off current from the battery. They are designed to help prevent tampering, theft, battery drain and electrical fires.

Battery Master Switches are available with brass or plated steel cases and are actuated by lever or hencol key.

Contacts are either silver or copper. O-rings feature in the operating shaft of some models for additional moisture and dirt protection.



## DPST On/Off Battery and Field Master Silver

75910BX

Australia's most reliable Battery Master Switch was developed by Cole Hersee in conjunction with ESG Asia Pacific and major mining corporations, to service a specific requirement.

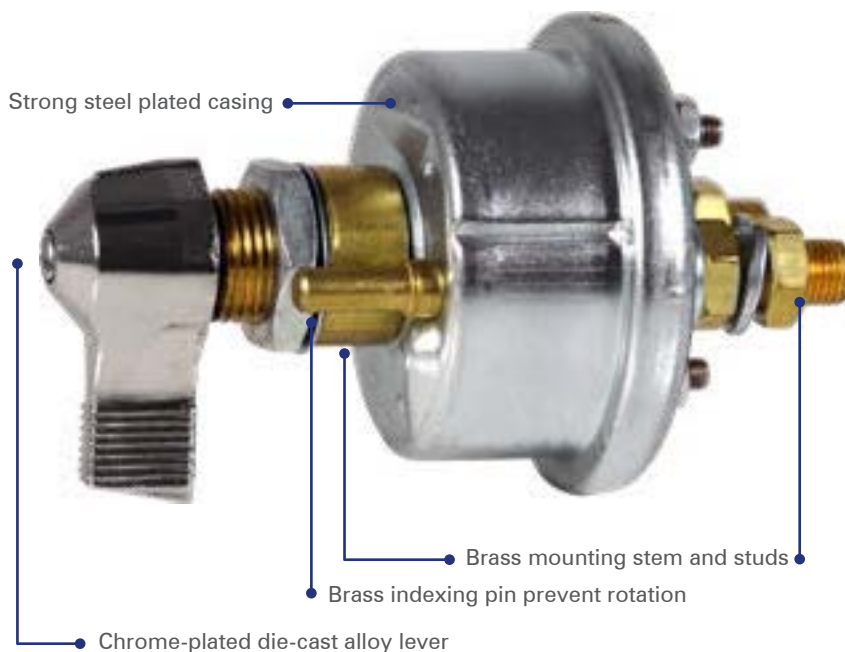

### Features

- + Silver contacts, chrome lever
- + Weather resistant, O-ring sealed

### Specifications





Voltage	6V-36V Multivoltage
Amperage	1000A Int, 125A Cont

### Part Numbers

75910BX	Boxed
---------	-------

# BATTERY MASTER SWITCHES

## SELECTION GUIDE

Part Number	24024	75903	75904	75907	75910
Battery Inputs	1	2	2	2	2
Switch Positions	2	2	2	2	2
Alternator Field Disconnect (AFD)	No	Yes	Yes	Yes	Yes
Make Before Break Contact	No	Yes	Yes	Yes	Yes
Maximum Operating Voltage	36V DC	36V DC	36V DC	36V DC	36V DC
Continuous Rating (studs)	175A	Large: 175A Small: 20A	Large: 175A Small: 20A	Large: 300A Small: 20A	Large:125A Small: 20A
Intermittent Rating (5 min)	400A	1000A	400A	1000A/20A	800A/20A
Cranking Rating (30 sec)	N/R	1000A	1000A min	1000A/20A min.	800A/20A min
Inrush Rating	400A	1000A	1000A	1000A/20	1000A/20
Cable Size required to Meet Ratings	1/0	2/0	2/0	4/0	2/0
Temperature Range	-40 to +85°C	-40 to +85°C	-40 to +85°C	-40 to +85°C	-40 to +85°C
Terminal Stud Size	3/8"-24	3/4"-16	3/4"-16	3/4"-16	3/4"-16
Terminal Stud Length	0.690" (17.5mm)	0.690" (17.5mm)	0.690" (17.5mm)	0.690" (17.5mm)	0.690" (17.5mm)
Maximum Terminal Stud Torque	8-10 Nm	8-10 Nm	8-10 Nm	8-10 Nm	8-10 Nm
Terminal Stud Material	Brass	Copper	Brass	Copper	Brass
Lock Out/Tag Out	with 24505	with 24505	with 24505	with 24505	with 24505
Actuator	2 Prong Key	Chrome Lever	Chrome Lever	Diecast Lever	Chrome Lever
Ignition Protected	No	No	No	No	No
Ingress Protection	IP55	IP55	IP55	IP64	IP64
Mounting Stem	3/4"-16	3/4"-16	3/4"-16	3/4"-16	3/4"-16
Anti-Rotation Pin	Yes	No	No	Yes	Yes
					

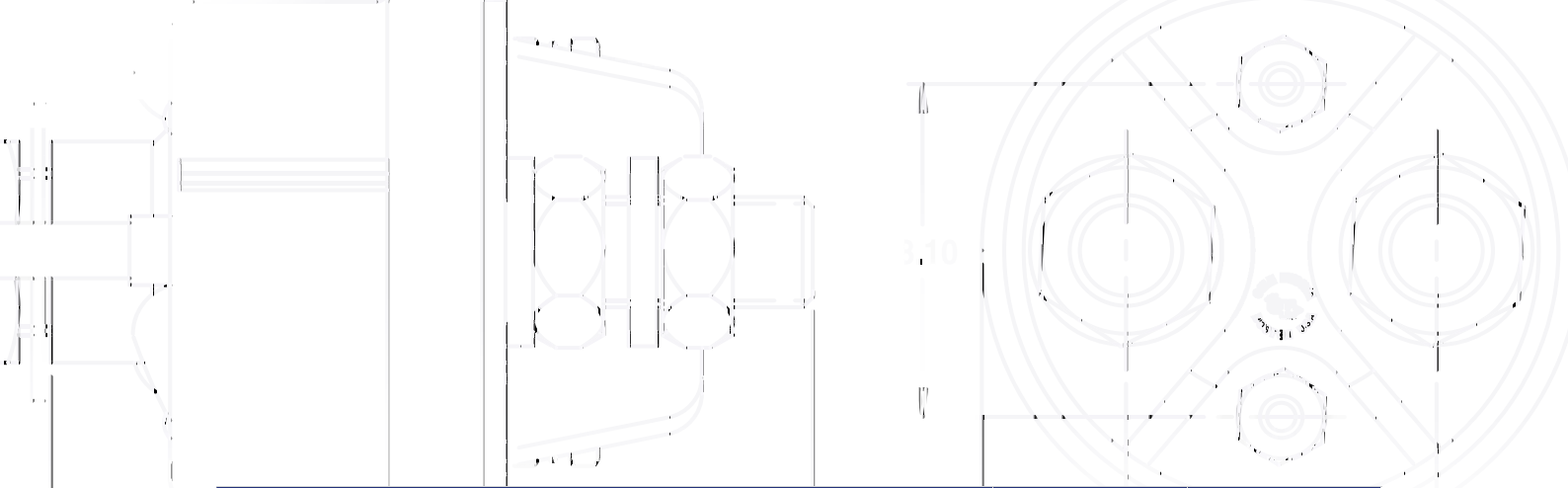

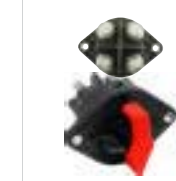
75912	75920	75920-01	880175	880175-0001	880175-0002
2	1	1	2	2	2
2	2	2	2	2	2
No	No	No	No	No	No
No	N/A	N/A	No	No	No
36V DC	36V DC	36V DC	48V DC	48V DC	48V DC
2 X 125A	400A	400A	500A	500A	500A
2x 750A	400A	400A	1000A	1000A	1000A
750A each min.	2,000A	2,000A	2,250A	2,250A	2,250A
2x 1000A	2,000A	2,000A	3,000A (1 sec)	3,000A (1 sec)	3,000A (1 sec)
2/0	4/0	4/0	4/0	4/0	4/0
-40 to +85°C	-40 to +85°C	-40 to +85°C	-50 to +85°C	-50 to +85°C	-50 to +85°C
3/4"-16	3/4"-16	3/4"-16	M12	M12	M12
0.690" (17.5mm)	3/4" (19mm)	3/4" (19mm)	0.984" (25mm)	0.984" (25mm)	0.984" (25mm)
8-10 Nm	8 Nm	8 Nm	30 Nm	30 Nm	30 Nm
Brass	Tin-Plated Copper	Tin-Plated Copper	Tin-Plated Copper	Tin-Plated Copper	Tin-Plated Copper
with 24505	Yes	Yes	Yes	Yes	Yes
Chrome Lever	Red Knob	Yellow Knob	Black Knob	Red Knob	Yellow Knob
No	No	No	SAE J11 & ISO 8846	SAE J11 & ISO 8846	SAE J11 & ISO 8846
IP64	IP68	IP68	IP67 & IP69K	IP67 & IP69K	IP67 & IP69K
3/4"-16	3/4"-16	3/4"-16	N/A	N/A	N/A
Yes	Yes	Yes	-	-	-
					

## DPST On/Off Battery Master Switch Lockout

24505-01

This Cole Hersee Battery Master Switch will disconnect the battery and the alternator or generator field circuit.

The 75910 Cole Hersee Battery Master Switch is the Australian approved switch by major mining corporations.

For peace of mind use a Cole Hersee lockout lever and flange plate that can accept a padlock to securely lock a Disconnect Switch in the Off position.

### Features

- DPST, Silver contacts, chrome lever
- Weather resistant, O-ring sealed
- Field terminals 20A continuous
- Indexing pin aligns switch and prevents rotation
- 2 x Field stud 10-32
- 2 x Battery stud 3/8"-24
- Mounting stem 3/4"-24 thread, L 13mm
- Suits panel thickness to 6.5mm
- Accepts padlocks up to 6mm diameter

### Specifications

Voltage	6V-36V Multivoltage
Amperage	1000A Intermittent, 125A Continuous, Small: 20A Cont
Dimensions	H 110 x Ø 67
Configuration	DPST
Modes	On/Off
Application	Heavy Duty, Mining

### Lever Part Numbers

- 24505-01B Chrome Lever
- 24505-01RB Red Lever
- 24505-01YB Yellow Lever



## Master Battery Disconnect Switch SPST On/Off

75920BX

### Features

- Strong black ABS body
- Copper Studs
- Built-in lock-out / tag-out
- Indexing pin aligns switch and prevents rotation
- O-ring seal on mounting shaft
- Red or yellow locking actuator handle
- 2 x Battery studs 3/8"-24
- Mounting stem 3/4"-16 thread, L22mm
- Suits panel thickness 12mm
- IP68 waterproof and dust proof; switch can be mounted in exposed locations

### Specifications

Voltage	6V-36V Multivoltage
Amperage	300A Continuous, 1000A to 3000A Intermittent
Dimensions	H 136 x D 86 x W x 70
Configuration	SPST
Modes	On/Off
Application	Heavy Duty, Mining, Agriculture, Marine

### Part Numbers

- 75920BX Red Handle
- 75920-01BX Yellow Handle





## TR Dual Pole Heavy Duty Battery Master Switch

880175BX

This dual pole 500A Battery Master Switch cuts all battery power from vehicle electrical systems with applications needing switching of two circuits, or both positive and negative.

### Features

- 2 x Battery studs 3/8"-24
- Built-in lock-out / tag-out
- Terminal stud size: M12 x 25mm.
- Temperature range: -50° to 85°C, DC-Rated to 105°C
- Shock: 30G, Vibration: 8G
- IP67 waterproof and dust proof; switch can be mounted in exposed locations

### Specifications

- Voltage 6V-48V Multivoltage
- Amperage 500A Continuous, with 2 x 4/0 input and 2 x 4/0 output cables
- Dimensions H 85 x D 103 x W x 120
- Configuration DPST
- Modes On/Off

### Part Numbers

- 880175BX Black Handle
- 880175-0001BX Red Handle
- 880175-0002BX Yellow Handle



## Battery and Field Master Switch DPST On/Off

75907BX

This Battery and Field Master Switch will disconnect the battery and the alternator or generator field circuit.

### Features

- Battery and Field Master Switching
- Silver contacts, chrome lever
- Weather resistant, O-ring sealed
- Field terminals 20A continuous
- Indexing pin aligns switch and prevents rotation
- 2 x Field stud 10-32
- 2 x Battery stud 3/8"-24
- Mounting stem 3/4"-24 thread, L 13mm
- Suits panel thickness to 6.5mm

### Specifications

- Voltage 6V-36V Multivoltage
- Amperage 2000A Intermittent, 300A Continuous, Small: 20A Cont
- Dimensions H 110 x Ø 67
- Configuration DPST
- Modes On/Off
- Application Heavy Duty, Mining

### Part Numbers

- 75907BX Boxed

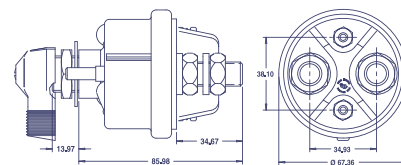

## Battery and Field Master Silver DPST On/Off

75904BX

This Battery and Field Master Switch will disconnect the battery and the alternator or generator field circuit.

### Features

- Battery and Field Master Switching
- Silver contacts, chrome lever
- Weather resistant, O-ring sealed
- Field terminals 20A continuous
- Indexing pin aligns switch and prevents rotation (key start only)
- 2 x Field stud 10-32
- 2 x Battery stud 3/8"-24
- Mounting stem 3/4"-24 thread, L 13mm
- Suits panel thickness to 6.5mm

### Specifications

- Voltage 6V-36V Multivoltage
- Amperage 1000A Intermittent, 125A Continuous, Small: 20A Cont
- Dimensions H 91 x Ø 67
- Configuration DPST
- Modes On/Off
- Application Heavy Duty, Mining

### Part Numbers

- 75904BX Lever switch
- 75904-03BX Key start switch



Indexing pin (key start only)

## Battery and Field Master Copper DPST On/Off

75903BX

This Battery and Field Master Switch will disconnect the battery and the alternator or generator field circuit.

### Features

- Battery and Field Master Switching
- Copper contacts, chrome lever
- Weather resistant
- Field terminals 20A continuous
- 2 x Field stud 10-32
- 2 x Battery stud 3/8"-24
- Mounting stem 3/4"-24 thread, L 13mm
- Suits panel thickness to 6.5mm

### Specifications

- Voltage 6V-36V Multivoltage
- Amperage 1000A Intermittent, 125A Continuous, Small: 20A Cont
- Dimensions H 110 x Ø 67
- Configuration DPST
- Modes On/Off

### Part Numbers

- 75903BX Boxed

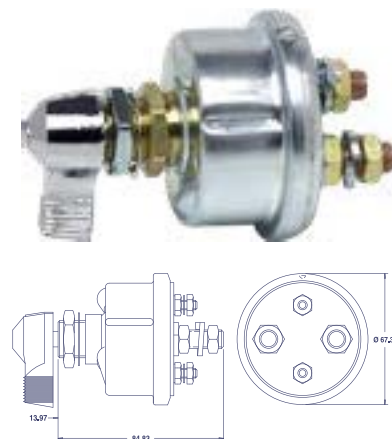

## Dual Battery Master Switch 4 Main Studs DPST

75912BX

This switch can be used to switch positive and negative at the same time, or for two separate circuits.

### Features

- Suitable for two high current loads
- Silver contacts, chrome lever
- Weather resistant, O-ring sealed
- Battery 4 x stud 3/8"-24 studs
- Indexing pin aligns switch and prevents rotation
- Mounting stem 3/4"-24 thread, L 13mm
- Suits panel thickness to 6.5mm

### Specifications

- Voltage 6V-36V Multivoltage
- Amperage 750A Intermittent x 2, 125A Continuous x 2
- Dimensions H 110 x Ø 67
- Configuration DPST
- Modes On/Off
- Application Heavy Duty, Mining

### Part Numbers

- 75912BX Boxed

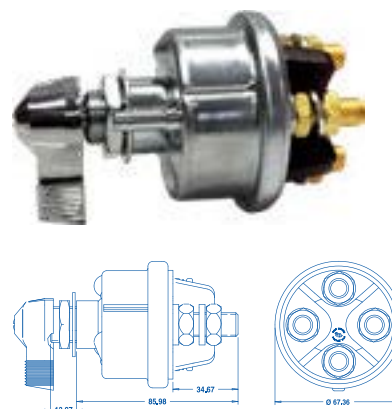

## Marine Battery Master Switch DPST On/Off

M290-05BX

This Marine Battery Master Switch will disconnect the battery preventing drain.

### Features

- Silver laminated contacts
- Brass case, chrome lever
- Field term 20A continuous
- 2 stud terminals 10-32
- Mounting stem 3/4"-24 thread
- Mounting stem length 46mm
- Suits panel thickness up to 23mm
- UL rating 707B

### Specifications

- Voltage 6V-36V Multivoltage
- Amperage 800A Intermittent, 125A Continuous, Small: 20A Cont
- Dimensions H 86 x Ø 67
- Configuration DPST
- Modes On/Off
- Application Heavy Duty, Marine

### Part Numbers

- M290-05BX Boxed

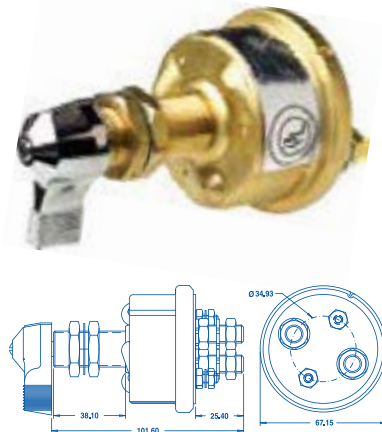

## CAT OEM Battery Master SPST On/Off with Key

24024BX

CAT OEM Battery Master Switch replaces 7N0718

### Features

- Two prong key type
- Silver laminated contacts, chrome lever
- Weather resistant O-ring sealed
- Indexing pin aligns switch and prevents rotation
- 2 stud terminals 10-32
- Mounting stem 3/4"-24 thread, L 13.5mm
- Suits panel thickness 6.5mm to 19mm

### Specifications

- Voltage 6V-36V Multivoltage
- Amperage 1000A Intermittent, 125A Continuous
- Dimensions H 86 x Ø 67
- Configuration SPST
- Modes On/Off
- Application Heavy Duty, Mining

### Part Numbers

- 24024BX Boxed





**M750 Series**

---



# BATTERY MASTER SWITCHES

In a dual battery system, one battery is used for starting the engine while the other is used to power auxiliary loads. A battery selector switch enables the use of the first battery, the second battery or both batteries simultaneously.

A dual battery system with a battery selector switch provides backup starting power in an emergency. One application is to put two batteries together (in parallel) to start the engine in cold weather.

If the primary battery is not at full power, the second battery can be used. This assures the availability of adequate power for starting. It also enables the user to select either battery for charging.

It will provide battery disconnect, protection against electrical fire, tampering, theft and battery drain when the vehicle, equipment or boat is unattended.

When using a dual battery charger it is necessary to separate the batteries while the charger is operating.

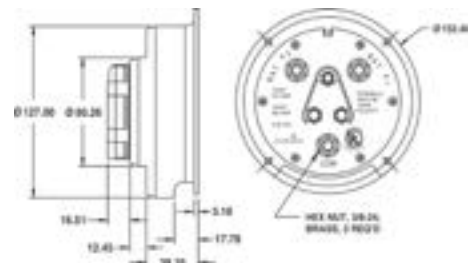
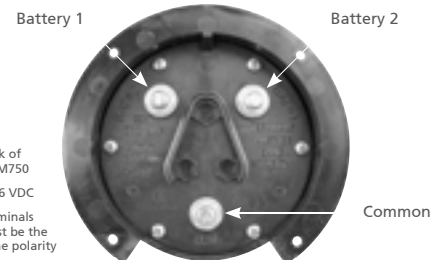
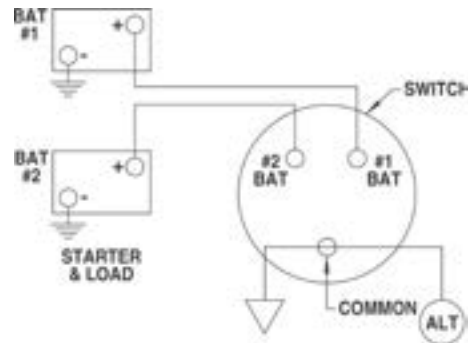

The batteries must be independent of each other for the dual battery charger to operate properly. The selector switch must be turned to the OFF position to avoid damage to the charger.

## Dual Battery Switch Selector and Disconnect

## M750

This Dual Battery Switch Selector and Disconnect switch will suit any vehicle that needs to use two batteries where one battery is used for starting the engine, while the other is used to power auxiliary loads. UL rating 707B.

This is a common situation in trucks, boats, RVs, police and rescue vehicles, and in ambulances and fire equipment.

### Features

- High impact and plastic case and knob
- High temperature engineered plastic
- 4 Position dual battery control
- Heavy duty copper stud terminals 3/8

### Specifications

- Voltage 6V-36V Multivoltage
- Amperage 500A Intermittent, 310A Continuous
- Dimensions H 67 x Ø 127
- Modes 1: Batteries OFF  
2: Battery #1 ON  
3: Battery #1&2 ON  
4: Battery #2 ON
- Application Heavy Duty

### Part Numbers

- M750 Clam blister





# **Rocker** ---

## **& Toggle Switches**

# ROCKER & TOGGLE SWITCHES

**Rocker and Toggle Switches are manufactured in many different variations to handle most vehicle and equipment applications. Rocker and Toggle Switches are usually classified by the number of poles and throws to identify their basic operation.**

Rocker switches can be either snap-in or bracket mounting, actuators can be illuminated or imprinted, contain pilot lights, or have both pilot lights and imprinting. Housings are usually plastic, however some models feature plastic with a metal bezel or mounting bracket.

Toggle switches are available with ball, short or long handles, paddle or illuminated actuators. Housings are either plastic, plastic and metal combined, or die-cast metal.

Cole Hersee Rocker and Toggle Switches can be used in 6, 12, 24 and 36 volt systems, and are rated up to 35 amp inductive load and 25 amp lamp load at 12 volts.

They can be used in applications such as signalling and marker lamps, windshield wiper systems, fuel selector valves, heater systems, headlight systems, and more.

Amperage requirements differ from application to application. Clearance and marker lamps on a 12 volt truck system for example, can require from less than one to just over two amps to operate. Other applications may require anywhere from five to eight amps.

When switches are turned On or Off, they must handle more current or voltage than is required to operate in a steady state—Cole Hersee switches are built to handle these requirements.



## Weather Resistant Features

A PVC (Polyvinyl Chloride) coating is applied to the switch body for effective sealing and protection from moisture, dirt and the elements. PVC coated switches usually come with wire leads that permit complete covering and insulation of the terminals.

Neoprene seals (O-rings) within the mounting stem protect against moisture and dirt from entering around the base of the actuator handle.

Also available are protective durable Silicone Rubber Boots that fit over the toggle handles and fasten securely to the mounting stem, making the toggle switch adaptable for use where moisture, dirt and similar elements are present.

Available in two styles: one covers the entire toggle handle (81264), the other allows the handle to protrude (81255).



### Part Numbers

• 81264BX	• Grey	• 81264-05BX	• Red
• 81264-01BX	• Black	• 81264-07BX	• Yellow
• 81264-02BX	• Blue	• 81255BX	• Grey half

## Rocker and Toggle Switch Capabilities

### Single Pole (SP)

A switch that opens, closes or changes connection of a single conductor in an electrical circuit.

### Double Pole (DP)

A switch that opens, closes or changes connection of two conductors in an electrical circuit.

### Single Throw (ST)

A switch that opens, closes or completes a circuit at only one of the extreme positions of its actuator.

### Double Throw (DT)

A switch that opens, closes or completes a circuit at both extreme positions of its actuator.

*Note: "Pole" should not be confused with "Terminal". The DPST switch, for example has four terminals however is a Double Pole (DP) and not a Four Pole (4P) switch.*

### SPST On/Off

Switch controls a single wire circuit.



### SPDT On/On and SPDT On/Off/On

Switch controls two single wire circuits, permitting only one circuit to be energised at a time.



### DPST On/Off

Switch controls two single wire circuits, permitting only one circuit to be energised at a time.



### DPDT On/On and DPDT On/Off/On

Switch controls two circuits, permitting only two circuits to be energised at a time.

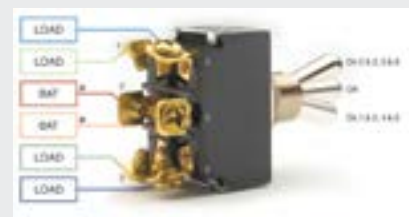



## Rocker Switch Mounting Accessories

### Bezels for Mounting Switches Side by Side

For snap-in mounting of any regular size switch such as 58312 and 58328 series. Bezels can be arranged in a parallel array of any length.

Bezels themselves can snap into a panel, or be mounted with the Bracket Mounting Kit.



#### Part Numbers

98628BX	Blank	82159-3B	End
82159-2BX	Centre	82159-3B	Single

### Snap-together Bracket Mounting Kit

For installing an array of switches onto a panel, when through mounting isn't possible. Use in conjunction with 82159 bezels.

Holds from 2 to 6 bezels. Snap-together assembly. Kit contains two bracket sections and brass stabilising rods.

Kit brackets engage with bezels. Brass rods snap into brackets to stabilize the unit.



#### Part Numbers

87167-01BP	Boxed
------------	-------

## 58312 Series - Sealed Rocker Switches with LED Pilot Lights

The 58312 Series Switches feature modern LED technology which gives a wide illumination angle, low power consumption and long service life, meaning no globes to change. IP66 rated.

With silver contacts for superior switching performance, and modern rounded edges and actuators, these matte finish switches fit perfectly into any modern vehicle or machine.



# SPST On/Off Dependent LED Rocker Switch

58312-A4BX

The 58312 Series switches feature modern LED technology which gives a wide illumination angle, low power consumption and long service life.

### Features

- Dependent operation, on with load
- 3 Blade terminals, silver contacts
- Wide bezel black, snap in mounting
- Weather resistant IP66 sealed
- Fits panel 2.4mm – 4.7mm
- Panel hole: W 21.1mm, H 36.8mm

### Specifications

- Voltage 12V
- Amperage 25A@12V
- Dimensions H 44 x D 41 x W 25

### Part Numbers

- 58312-A4BX Amber
- 58312-C4BX Clear
- 58312-G4BX Green
- 58312-R4BX Red



## Illumination

### Dependent vs Independent

Dependent illumination means the lamp in the switch is powered by the load. Therefore, when the switch is off, the lamp is off. When the switch is on, the lamp is illuminated.

This makes it easy to see when the load is active. These switches are also available as On/On and On/Off/On with dual dependent illumination.



### Independent + Dependent Illumination

Independent illumination means that a separate electrical signal or switch powers the lamp, regardless of what function the switch is performing at any one time.

For example, the independent lamp might be wired to the dash lights of a vehicle to make the switch visible in the dark. Or it could be used as a driving light switch with the independent lamp signaling when the headlights are active.

The independent + dependent switches enable a pilot light to be illuminated and an additional lamp to be illuminated when the switch is actuated.



## SPDT On/Off/On Dependent LED Rocker Switch

58312-AGBX

The 58312 Series switches feature modern LED technology which gives a wide illumination angle, low power consumption and long service life.

### Features

- Dependent LED's x 2, On with Load
- 4 Blade terminals, silver contacts
- Wide bezel black, snap in mounting
- Weather resistant IP66 sealed
- Fits panel 2.4mm – 4.7mm
- Panel hole: W 21.1mm, H 36.8mm

### Specifications

- Voltage 12V
- Amperage 25A@12V
- Dimensions H 44 x D 41 x W 25

### Part Numbers

- 58312-AGBX Amber/Green

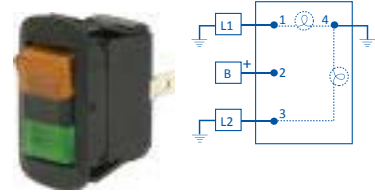

## SPST On/Off Dependent Pilot Rocker Switch

58328-13BX

Rocker Switches are manufactured in many different variations to handle most vehicle and equipment applications and are usually classified by the number of poles and throws to identify their basic operation.

### Features

- Dependent pilot On with load
- Black actuator illuminated
- 3 Blade terminals, silver contacts
- Wide bezel, snap in mounting
- Range of colour options
- Fits panel 2.36mm – 4.73mm
- Panel hole: W 21.1mm, H 36.8mm

### Specifications

- Voltage 12V or 24V
- Amperage 25A@12V
- Dimensions H 43 x D 41 x W 24
- Configuration SPST
- Modes On/Off

### Part Numbers

- 58328-04BX Red 12V
- 58328-11BX Green 12V
- 58328-12BX Clear 12V
- 58328-13BX Amber 12V
- 58328-55BX Blue 12V
- 58328-58BX Red 24V
- 58328-62BX Amber 24V



## 58326 Series - Sealed Rocker Switches with Incandescent Pilot Lights

The Incandescent Paddle Series Rocker Switches feature imprinted automotive symbols on some models.

With silver contacts for superior switching performance, these matte finish switches fit perfectly into any modern or classic vehicle or machine.



## SPST On/Off Illuminated Symbol Rocker

58326-01BRX

### Features

- Independent illumination, Term 7 & 8
- Sealed, blade terminals, silver contacts
- Nylon wide bezel, snap in mounting
- Supplied with neoprene panel seal
- Fits panels 2.35mm – 4.73mm
- Panel hole: W 21.1mm, H 36.8mm

### Specifications

- Voltage 12V
- Amperage 25A@12V
- Dimensions H 49 x D 39 x W 24
- Configuration SPST
- Modes On/Off

### Part Numbers

- 58326-01BRX Red Blank

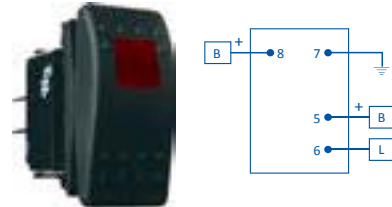

## DPDT Off/On/Mom On Illuminated Symbol

58326-11BX

### Features

- Independent illumination, Term 7 & 8
- SPST Off/On Term 2 & 3
- SPDT Mom On Term 5 & 6
- Sealed, blade terminals, silver contacts
- Nylon wide bezel, snap in mounting
- Supplied with neoprene panel seal
- Fits panels 2.35mm – 4.73mm
- Panel hole: W 21.1mm, H 36.8mm

### Specifications

- Voltage 12V
- Amperage 25A@12V
- Dimensions H 49 x D 39 x W 24
- Configuration SPST
- Modes Off/On/Mom On

### Part Numbers

- 58326-11BX White Warning

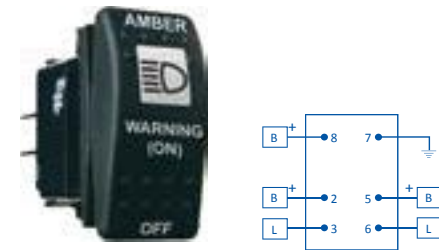

## DPDT On/On/On Illuminated Symbol Rocker

58326-29BX

### Features

- Independent illumination, Term 7 & 8
- On 1&2, 4&5> On 2&3, 4&5> On 2&3, 5&6
- Sealed, blade terminals, silver contacts
- Nylon wide bezel, snap in mounting
- Supplied with neoprene panel seal
- Fits panels 2.35mm – 4.73mm
- Panel hole: W 21.1mm, H 36.8mm

### Specifications

- Voltage 12V
- Amperage 25A@12V
- Dimensions H 49 x D 39 x W 24
- Configuration DPTT
- Modes On/On/On

### Part Numbers

- 58326-29BX White Fan

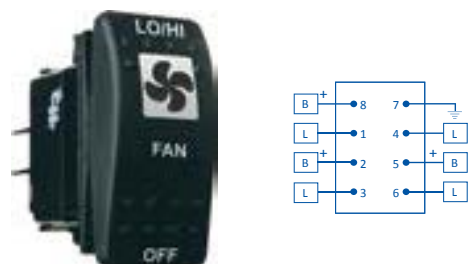



## 58311 Series - IP66 Sealed Weather Resistant Rocker Switches

The 58311 Series Switches feature silver contacts for superior switching performance, and modern rounded edges and actuators, these matte finish switches fit perfectly into any modern vehicle or machine.

They are also IP66 rated.



### SPST Sealed Blank Rocker Switch

**58311-02BX**

#### Features

- 2 Blade terminals, silver contacts
- Wide bezel black, snap in mounting
- Weather resistant IP66 sealed
- Fits panels 2.35mm - 4.73mm
- Panel hole: W 21.1mm, H 36.8mm

#### Specifications

- Voltage 12/24V Dual voltage
- Amperage 25A@12V, 12A@24V
- Dimensions H 44 x D 41 x W 25

#### Part Numbers

- 58311-02BX Off/Mom On

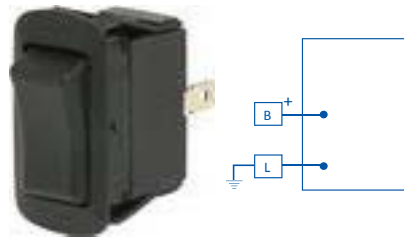

### DPST Sealed Blank Rocker Switch

**58311-08B**

#### Features

- 6 Blade terminals, silver contacts
- Wide bezel black, snap in mounting
- Weather resistant IP66 sealed
- Polarity reversing
- Fits panels 2.35mm - 4.73mm
- Panel hole: W 21.1mm, H 36.8mm

#### Specifications

- Voltage 12/24V Dual voltage
- Amperage 25A@12V, 12A@24V
- Dimensions H 44 x D 41 x W 25

#### Part Numbers

- 58311-08B On/On

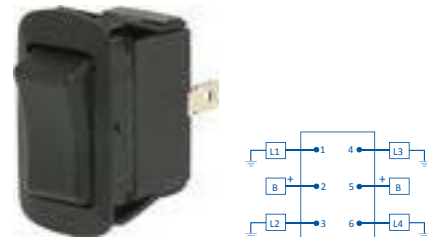

## SPST Non-Illuminated Blank Rocker Switch

58027-01BX

### Features

- 2 Blade terminals, silver contacts
- Narrow black bezel, snap in mounting
- Fits panels 2.35mm - 4.73mm
- Panel hole: W 21.1mm, H 36.8mm

### Specifications

- Voltage 12/24V Dual voltage
- Amperage 25A@12V, 12A@24V
- Dimensions H 43 x D 41 x W 24

### Part Numbers

- 58027-01BX On/Off
- 58027-02BX Off/Mom On

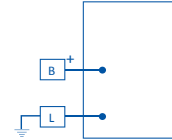

## SPDT Non-Illuminated Blank Rocker Switch

58027-03BX

### Features

- 3 Blade terminals, silver contacts
- Narrow black bezel, snap in mounting
- Fits panels 2.35mm - 4.73mm
- Panel hole: W 21.1mm, H 36.8mm

### Specifications

- Voltage 12/24V Dual voltage
- Amperage 25A@12V, 12A@24V
- Dimensions H 43 x D 41 x W 24

### Part Numbers

- 58027-03BX On/Off/On
- 58027-04BX Mom On/Off/Mom On

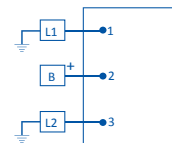

## DPDT On/Off/On Non-Illuminated Blank Rocker

58027-07BX

### Features

- 6 Blade terminals, silver contacts
- Narrow black bezel, snap in mounting
- Fits panels 2.35mm - 4.73mm
- Panel hole: W 21.1mm, H 36.8mm

### Specifications

- Voltage 12/24V Dual voltage
- Amperage 25A@12V, 12A@24V
- Dimensions H 43 x D 41 x W 24

### Part Numbers

- 58027-07BX On/Off/On

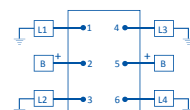

## DPDT Mom On/Off/Mom On Reversing Rocker

58027-11BX

### Features

- Polarity reversing
- 6 Blade terminals, silver contacts
- Narrow black bezel, snap in mounting
- Fits panels 2.35mm - 4.73mm
- Panel hole: W 21.1mm, H 36.8mm

### Specifications

- Voltage 12/24V Dual voltage
- Amperage 25A@12V, 12A@24V
- Dimensions H 43 x D 41 x W 24

### Part Numbers

- 58027-11BX Mom On/Off/Mom On

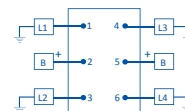

## Blank Rocker and Toggle Switch 12V, 24V, 36V Ratings

Generally, Cole Hersee heavy duty 12V non-illuminated\* Rocker and Toggle Switches can be used at higher voltage but lower current.

Example: By calculation, 25A 12V switch will derate to 8.3A at 36V, or 12.5A at 24V. This calculated de-rating gives a conservative result. 25A at 12V Toggle Switches\* can actually be used at 15A at 24V, and 10A at 36V.

\*Exception: This does not apply to Illuminated switches. The pilot light must only be supplied with the stated voltage. Do not derate any illuminated switches.



## SPST On/Off Sealed Marine Blank Rocker Switch

M58031-01BX

### Features

- Water resistant, IP66 rating, UL 1500
- Supplied with neoprene panel seal
- 2 Blade terminals, silver contacts
- Wide black bezel, snap in mounting
- Fits panels 2.35mm - 4.73mm
- Panel hole: W 21.1mm, H 36.8mm

### Specifications

- Voltage 12/24V Dual voltage
- Amperage 20A@12V, 10A@24V
- Dimensions H 49 x D 39 x W 24

### Part Numbers

- M58031-01BX On/Off

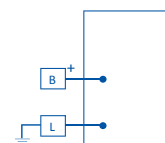

## SPST Off/Mom On Sealed Marine Blank Rocker

M58031-07BX

### Features

- Water resistant, IP66 rating, UL 1500
- Supplied with neoprene panel seal
- 2 Blade terminals, silver contacts
- Wide black bezel, snap in mounting
- Fits panels 2.35mm - 4.73mm
- Panel hole: W 21.1mm, H 36.8mm

### Specifications

- Voltage 12/24V Dual voltage
- Amperage 20A@12V, 10A@24V
- Dimensions H 49 x D 39 x W 24

### Part Numbers

- M58031-07BX Off/Mom On

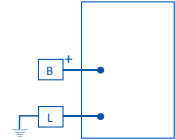

## SPDT On/Off/On Sealed Marine Blank Rocker

M58031-02BX

### Features

- Water resistant, IP66 rating, UL 1500
- Supplied with neoprene panel seal
- 3 Blade terminals, silver contacts
- Wide black bezel, snap in mounting
- Fits panels 2.35mm - 4.73mm
- Panel hole: W 21.1mm, H 36.8mm

### Specifications

- Voltage 12/24V Dual voltage
- Amperage 20A@12V, 10A@24V
- Dimensions H 49 x D 39 x W 24

### Part Numbers

- M58031-02BX On/Off/On

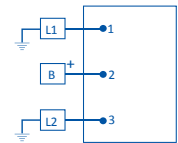

## DPST On/Off Sealed Marine Blank Rocker

M58031-04BX

### Features

- Water resistant, IP66 rating, UL 1500
- Supplied with neoprene panel seal
- 4 Blade terminals, silver contacts
- Wide black bezel, snap in mounting
- Fits panels 2.35mm - 4.73mm
- Panel hole: W 21.1mm, H 36.8mm

### Specifications

- Voltage 12/24V Dual voltage
- Amperage 20A@12V, 10A@24V
- Dimensions H 49 x D 39 x W 24

### Part Numbers

- M58031-04BX On/Off

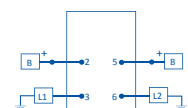



## SPST On/Off Dependent Pilot Rocker Switch

58327-01BX

### Features

- Dependent pilot On with load
- Black actuator illuminated
- 3 Blade terminals, silver contacts
- Wide bezel, snap in mounting
- Fits panel 2.36mm – 4.73mm
- Panel hole: W 21.1mm, H 36.8mm

### Specifications

- Voltage 12V
- Amperage 25A@12V
- Dimensions H 43 x D 38 x W 25
- Configuration SPST
- Modes On/Off

### Part Numbers

- 58327-01BX Boxed

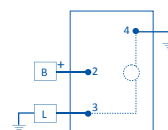

## SPST On/Off Locking Actuator Rocker Switch

58336BX

This Rocker Switch automatically locks the actuator into the Off position to help prevent accidental actuation. And must be slid to allow the actuator to be moved to the On position.

### Features

- Locking actuator, slide release
- Orange Lock on each operation
- 2 Blade terminals, silver contacts
- Fits panels 2.35mm to 4.73mm
- Panel hole: W 21.1mm, H 36.8mm

### Specifications

- Voltage 12V or 24V
- Amperage 25A@12V
- Dimensions H 43 x D 38 x W 25
- Configuration SPST
- Modes On/Off

### Part Numbers

- 58336BX Boxed

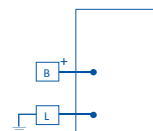

## SPST On/Off Illuminated Red Rocker Switch

54012BX

### Features

- 3 Blade terminals, silver contacts
- Narrow body, snap in mounting
- Fits panels thickness 1.35 - 5.15mm
- Panel hole W 14mm, H 28.6mm

### Specifications

- Voltage 12V
- Amperage 10A@12V
- Dimensions H 31 x D 35 x W 17

### Part Numbers

- 54012BX Boxed

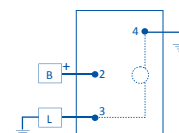

## Rocker Switch Mounting End Section

82159-1BX

### Features

- Rocker switch end panel
- Hole height 48.3mm, W 26.2mm for each section
- Accepts wide body rockers 58328, 58027, 58326, 58312 & 58311 series

### Specifications

- Dimensions H 59 x D 31 x W 31

### Part Numbers

- 82159-1BX Boxed

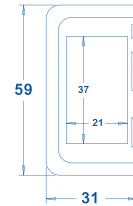

## Rocker Switch Mounting Centre Section

82159-2BX

### Features

- Rocker switch centre panel
- Hole height 48.3mm, W 26.2mm for each section
- Accepts wide body rockers 58328, 58027, 58326, 58312 & 58311 series

### Specifications

- Dimensions H 59 x D 31 x W 27

### Part Numbers

- 82159-2BX Boxed

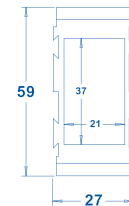

## Rocker Switch Mounting Independent Bezel

82159-3B

### Features

- Rocker switch independent bezel
- Hole height 48.3mm, W 25mm
- Accepts wide body rockers 58328, 58027, 58326, 58312 & 58311 series

### Specifications

- Dimensions H 48.3 x D 31 x W 25

### Part Numbers

- 82159-3B Boxed



## Rocker Switch Mounting Blank Insert Cover

98628BX

### Features

- Rocker blank insert
- Use with rocker switch mounting brackets 82159-1BX and 82159-2BX

### Specifications

- Dimensions H 48.3 x D 31 x W 25

### Part Numbers

- 98628BX Boxed



## SPST On/Off Blade Terminals Toggle Switch

55014BX

### Features

- 2 Blade terminals, silver contacts
- Stem: thread 15/32-32, L 12mm, D 12mm
- Panel thickness: 6.35mm, Handle: 17mm

### Specifications

- Voltage 12/24V Dual voltage
- Amperage 25A@12V, 12A@24V
- Dimensions H 29 x D 60 x W 16

### Part Numbers

- 55014BX Boxed

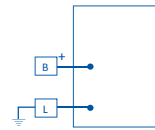

## SPST On/Off Screw Terminals Toggle Switch

5582BX

### Features

- 2 Screw terminals, silver contacts
- Stem: thread 15/32-32, L 12mm, D 12mm
- Panel thickness: 6.35mm, Handle: 17mm

### Specifications

- Voltage 12/24V Dual voltage
- Amperage 25A@12V, 12A@24V
- Dimensions H 29 x D 55 x W 16

### Part Numbers

- 5582BX Boxed

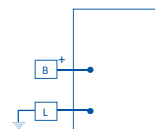

## SPST On/Off Sealed Leads Toggle Switch

5582-10BX

### Features

- O-ring in stem, silver contact
- Pre-wired, PVC coated housing
- Stem: thread 15/32-32, L 12mm, D 12mm
- Panel thickness: 6.35mm, Handle: 17mm

### Specifications

- Voltage 12/24V Dual voltage
- Amperage 25A@12V, 12A@24V
- Dimensions H 29 x D 55 x W 16

### Part Numbers

- 5582-10BX Boxed

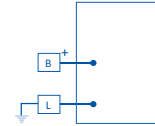

## SPDT On/On Screw Terminals Toggle Switch

5584BX

### Features

- 3 Screw terminals, silver contacts
- Stem: thread 15/32-32, L 12mm, D 12mm
- Panel thickness: 6.35mm, Handle: 17mm

### Specifications

- Voltage 12/24V Dual voltage
- Amperage 25A@12V, 12A@24V
- Dimensions H 29 x D 53 x W 16

### Part Numbers

- 5584BX Boxed

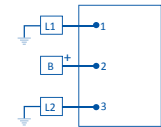

## DPDT On/Off/On Screw Terminals Toggle Switch

5592BX

### Features

- 6 Screw terminals, silver contacts
- Stem: thread 15/32-32, L 12mm, D 12mm
- Panel thickness: 6.35mm, Handle: 17mm

### Specifications

- Voltage 12/24V Dual voltage
- Amperage 25A@12V, 12A@24V
- Dimensions H 33 x D 48 x W 19

### Part Numbers

- 5592BX Boxed

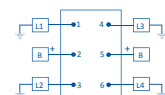

## SPDT On/Off/On Blade Screw Toggle Switch

5586BX

### Features

- 3 Screw terminals, silver contacts
- Stem: thread 15/32-32, L 12mm, D 12mm
- Panel thickness: 6.35mm, Handle: 17mm

### Specifications

- Voltage 12/24V Dual voltage
- Amperage 25A@12V, 12A@24V
- Dimensions H 29 x D55 x W 16

### Part Numbers

- 5586BX Boxed

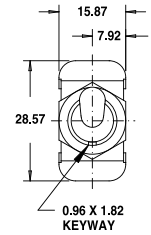

## IP68 SPDT On/Off/On Sealed Leads Toggle Switch

M55036BX

### Features

- O-ring in stem, silver contact
- Pre-wired, PVC coated housing
- Stem: thread 15/32-32, L 12mm, D 12mm
- Panel thickness: 6.35mm, Handle: 17mm

### Specifications

- Voltage 12/24V Dual voltage
- Amperage 25A@12V, 12A@24V
- Dimensions H 29 x D 55 x W 16

### Part Numbers

- M55036BX Boxed

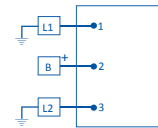

## SPST On/Off Blade Terminals Mini Toggle

M586BX

### Features

- 2 Blade terminals
- Stem: thread 15/32-32, L 12mm, D 12mm
- Panel thickness: 6.35mm, Handle: 17mm

### Specifications

- Voltage 12/24V Dual voltage
- Amperage 25A@12V, 12A@24V
- Dimensions H 32 x D 41 x W 13

### Part Numbers

- M586BX Boxed

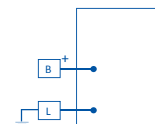



## SPST Off/Mom On Screw Terminals Toggle

55020BX

### Features

- 2 Screw terminals, silver contacts
- Stem: thread 15/32-32, L 12mm, D 12mm
- Panel thickness: 6.35mm, Handle: 17mm

### Specifications

- Voltage 12/24V Dual voltage
- Amperage 25A@12V, 12A@24V
- Dimensions H 28 x D 41 x W 16

### Part Numbers

- 55020BX Boxed

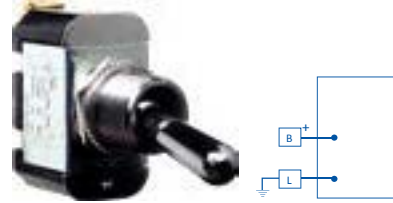

## SPDT Mom On/Off/Mom On Screw Terminals

55021BX

### Features

- 2 Screw terminals, silver contacts
- Stem: thread 15/32-32, L 12mm, D 12mm
- Panel thickness: 6.35mm, Handle: 17mm

### Specifications

- Voltage 12/24V Dual voltage
- Amperage 25A@12V, 12A@24V
- Dimensions H 34 x D 55 x W 19

### Part Numbers

- 55021BX Boxed

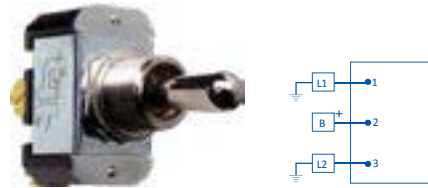

## SPDT Mom On/Off/Mom On Screw Terminals

55021-07BX

### Features

- O-ring in stem, silver contact
- Pre-wired, PVC coated housing
- Stem: thread 15/32-32, L 12mm, D 12mm
- Panel thickness: 6.35mm, Handle: 17mm

### Specifications

- Voltage 12/24V Dual voltage
- Amperage 25A@12V, 12A@24V
- Dimensions H 34 x D 55 x W 19

### Part Numbers

- 55021-07BX Boxed



## SPST On/Off Blade Terminals Long Handle

55055BX

### Features

- 2 Blade terminals, silver contacts
- Stem: thread 15/32-32, L 12mm, D 12mm
- Panel thickness: 6.35mm, Handle: 38mm

### Specifications

- Voltage 12/24V Dual voltage
- Amperage 25A@12V, 12A@24V
- Dimensions H 28 x D 94 x W 16

### Part Numbers

- 55055BX Boxed



## DPDT On/Off/On Blade Terminals Long Handle

55057BX

### Features

- 6 Blade terminals, silver contacts
- Stem: thread 15/32-32, L 12mm, D 12mm
- Panel thickness: 6.35mm, Handle: 38mm

### Specifications

- Voltage 12/24V Dual voltage
- Amperage 25A@12V, 12A@24V
- Dimensions H 34 x D 94 x W 19

### Part Numbers

- 55057BX Boxed



## SPST On/Off Blade Terminals Illuminated Red

M54111-01BX

### Features

- Clear Off, illuminates red On
- 4 Blade terminals, silver contacts
- Stem: thread 15/32-32, L 9mm, D 12mm
- Panel thickness: 6.35mm, Handle: 17mm

### Specifications

- Voltage 12V
- Amperage 25A@12V
- Dimensions H 35 x D 56 x W 16

### Part Numbers

- M54111-01BX Boxed



Independent Illumination

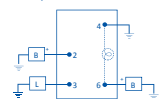

Dependent Illumination

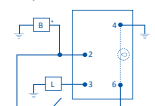

## DPDT On/Off/On Blade Long Handle Head Light

55064BX

### Features

- Bridged 4 circuit, headlamp switch
- 6 Blade terminals, silver contacts
- Stem: thread 15/32-32, L 12mm, D 12mm
- Panel thickness: 6.35mm, Handle: 38mm

### Specifications

- Voltage 12/24V Dual voltage
- Amperage 25A@12V, 12A@24V
- Dimensions H 34 x D 94 x W 19

### Part Numbers

- 55064BX Boxed

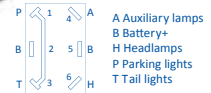

## SPDT On/Off/On Blade Terminals Paddle Toggle

59024-13BX

### Features

- Paddle handle (nylon), rep 'Freightliner'
- 3 Blade terminals, silver contacts
- Stem: thread 15/32-32, L 12mm, D 12mm
- Panel thickness: 6.35mm, Handle: 25mm

### Specifications

- Voltage 12/24V Dual voltage
- Amperage 25A@12V, 12A@24V
- Dimensions H 33 x D 67 x W 19

### Part Numbers

- 59024-13BX Boxed

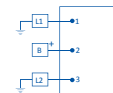

## DPDT On/On Blade Terminals Toggle Switch

55018BX

### Features

- 6 Blade terminals, silver contacts
- Stem: thread 15/32-32, L 12mm, D 12mm
- Panel thickness: 6.35mm, Handle: 17mm

### Specifications

- Voltage 12/24V Dual voltage
- Amperage 25A@12V, 12A@24V
- Dimensions H 34 x D 60 x W 19

### Part Numbers

- 55018BX Boxed

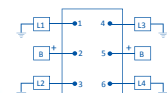

## DPDT On/Off/On Blade Terminals Toggle Switch

55019B

### Features

- 6 Blade terminals, silver contacts
- Stem: thread 15/32-32, L 12mm, D 12mm
- Panel thickness: 6.35mm, Handle: 17mm

### Specifications

- Voltage 12/24V Dual voltage
- Amperage 25A@12V, 12A@24V
- Dimensions H 34 x D 60 x W 19

### Part Numbers

- 55019B Boxed

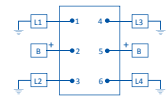

## DPDT Mom On/Off/On Blade Terminals Reversing

55081B

### Features

- Reversing polarity
- 6 Blade terminals, silver contacts
- Stem: thread 15/32-32, L 12mm, D 12mm
- Panel thickness: 6.35mm, Handle: 17mm

### Specifications

- Voltage 12/24V Dual voltage
- Amperage 25A@12V, 12A@24V
- Dimensions H 28 x D 58 x W 19

### Part Numbers

- 55081B Boxed

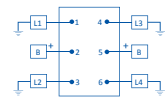

## DPDT Mom On/Off/Mom On Screw Reversing

55054BX

### Features

- Reversing polarity
- 6 Screw terminals, silver contacts
- Stem: thread 15/32-32, L 12mm, D 12mm
- Panel thickness: 6.35mm, Handle: 17mm

### Specifications

- Voltage 12/24V Dual voltage
- Amperage 25A@12V, 12A@24V
- Dimensions H 34 x D 58 x W 19

### Part Numbers

- 55054BX Boxed

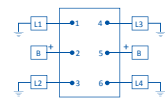

## DPDT Mom On/Off/Mom On Blade Reversing

55065-03BX

### Features

- Reversing polarity
- 6 Blade terminals, silver contacts
- Stem: thread 15/32-32, L 12mm, D 12mm
- Panel thickness: 6.35mm, Handle: 17mm

### Specifications

- Voltage 12/24V Dual voltage
- Amperage 25A@12V, 12A@24V
- Dimensions H 34 x D 58 x W 19

### Part Numbers

- 55065-03BX Boxed

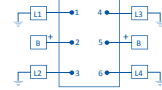

## DPDT Mom On/Off/Mom On Blade Reversing

55065-02BX

### Features

- Reversing polarity, long handle
- 6 Blade terminals, silver contacts
- Stem: thread 15/32-32, L 12mm, D 12mm
- Panel thickness: 6.35mm, Handle: 38mm

### Specifications

- Voltage 12/24V Dual voltage
- Amperage 25A@12V, 12A@24V
- Dimensions H 34 x D 58 x W 19

### Part Numbers

- 55065-02BX Boxed

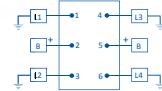

## DPDT Mom On/Off/Mom On Bridged Reversing

55046BX

This switch is used for changing direction of permanent magnet electric motors: fans, booms, conveyors etc.

### Features

- 4 Blade terminals, silver contacts

### Specifications

- Voltage 12/24V Dual voltage
- Amperage 25A@12V, 12A@24V
- Dimensions H 34 x D 69 x W 19

### Part Numbers

- 55046BX Boxed

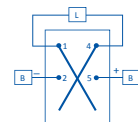



## Toggle Switch Silicone Sealing Boots

81264BX

### Features

- Highly-durable silicone rubber
- O-ring seal with the panel
- Silicone rubber, up to 17.5mm handle
- Suits thread 15/32-32, Screw on to fit

### Part Numbers

- 81264BX Grey
- 81264-01BX Black
- 81264-02BX Blue

### Part Numbers

- 81264-05BX Red
- 81264-07BX Yellow
- 81255BX Grey half



## Toggle Switch Security Cover Guard

82468BX

### Features

- For security of switch operation
- Spring-loaded snap action cover
- Stops accidental operation
- Rugged red melamine cover
- Suit D 12mm, Handle 18mm

### Specifications

- Dimensions H 47 x D 27 x W 18

### Part Numbers

- 82468BX Boxed

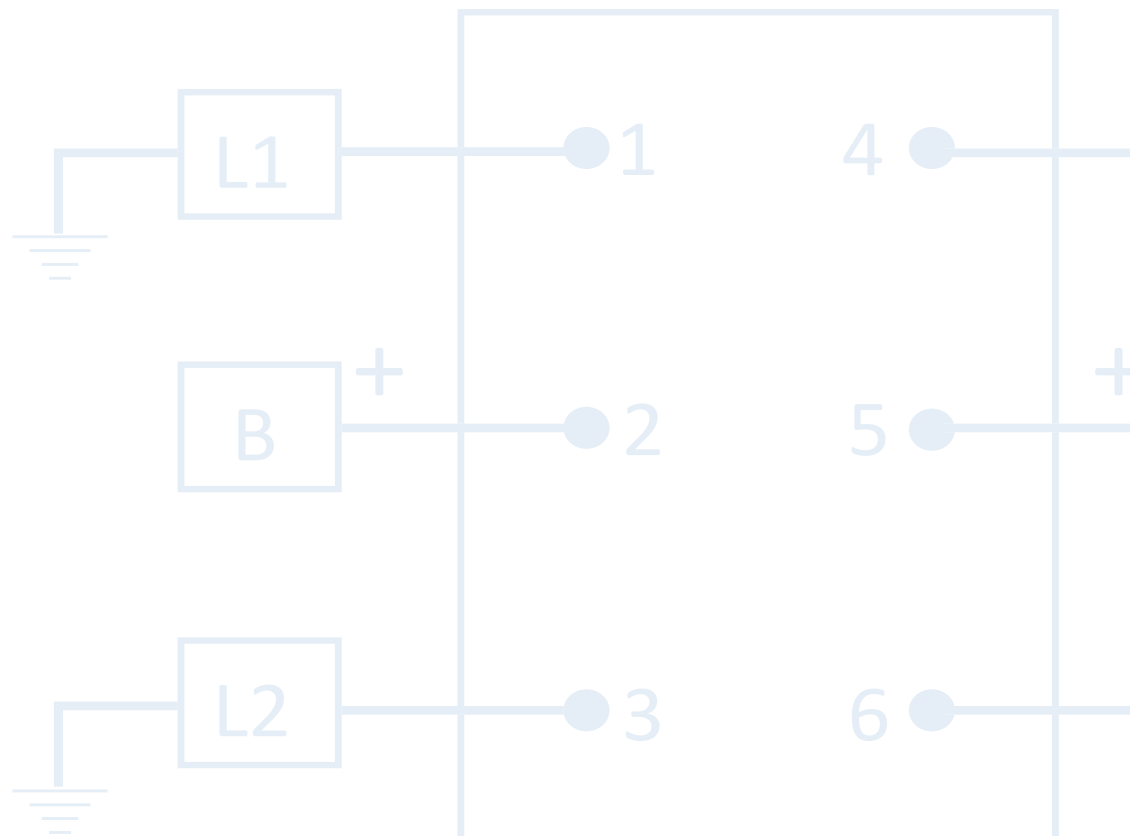



# Push Button Switches

---

**Push Button Switches (sometimes referred to as Momentary Switches) are most commonly used for Off/Mom On ignition type applications.**

Cole Hersee Push Button Switches are available in die-cast alloy or brass housing with most featuring chrome plated button and face nut or rubber capping. Some models feature a PVC coated body to help seal against moisture and dirt.



# PUSH BUTTON SWITCHES

## SPST Off/Mom On START Push Button Switch

90047BX

### Features

- 2 Screw terminals, silver contacts
- 'ENGINE START' imprint (black)
- 'ENGINE STOP' imprint (red)
- Embossed in white on black/red
- Impact resistant, repels water and oil
- Mounting hole 21mm
- Suits panel thickness 1mm to 2.5mm

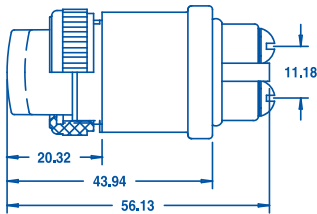

### Specifications

- Voltage 6V-36V Multivoltage
- Amperage 35A@12V, 20A@24V
- Dimensions H 56 x Ø 29
- Configuration SPST
- Modes Off/Mom On

### Part Numbers

- 90047BX Boxed (start)
- 90048BX Boxed (stop)



## SPST Off/Mom On Screw Push Button Switch

90030BX

### Features

- Spring return to Off
- 2 Screw terminals, silver contacts
- Protective weather/dustproof cap
- Mounting stem 5/8" – 32, Length 16mm
- Suits panel thickness 6.35mm-15.87mm

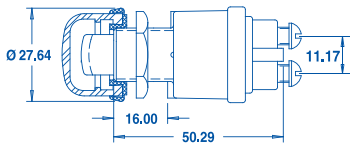

### Specifications

- Voltage 6V-36V Multivoltage
- Amperage 35A@12V, 20A@24V
- Dimensions H 60 x Ø 28
- Configuration SPST
- Modes Off/Mom On

### Part Numbers

- 90030BX Boxed



## SPST On/Mom Off Sealed Push Button Switch

90043BX

### Features

- Spring return to On
- Normally On, 2 blade terminals
- 2 Screw terminals (with lock washers)
- Mounting stem 5/8"-32, Length 22.3mm
- Suits panel thickness 12.7mm

### Specifications

- Voltage 6V-36V Multivoltage
- Amperage 10A@12V, 5A@24V
- Dimensions H 33 x D 62 x W 29

### Part Numbers

- 90043BX Boxed

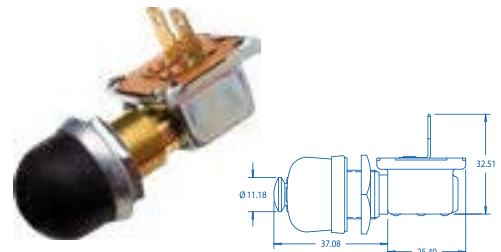

## SPST On/Mom Off Sealed Push Button Switch

90043-07BX

### Features

- Spring return to On
- Normally On, steel plunger
- Pre-wired PVC coated body
- Mounting stem 5/8"-32, Length 16mm
- Suits panel thickness 12.7mm

### Specifications

- Voltage 6V-36V Multivoltage
- Amperage 20A@12V, 10A@24V
- Dimensions H 33 x D 62 x W 29

### Part Numbers

- 90043-07BX Boxed



## SPST Off/Mom On Sealed Push Button Switch

M608BX

### Features

- Spring return to Off
- Pre-wired PVC coated housing
- Copper alloy contacts, brass body
- Mounting stem 5/8"-32, L 24mm
- Suits panel thickness 12.70mm

### Specifications

- Voltage 6V-36V Multivoltage
- Amperage 10A@12V, 5A@24V
- Dimensions H 33 x D 62 x W 29

### Part Numbers

- M608BX Boxed

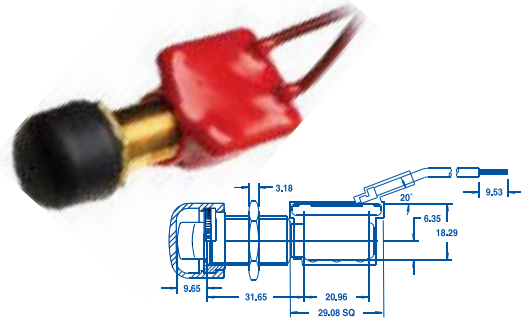

## SPST Off/On Sealed Push Button Switch

M606BX

### Features

- Pre-wired PVC coated housing
- Chrome plated brass knob and face nut
- Copper alloy contacts, dia 22.3mm
- Suits panel thickness up to 15.87mm

### Specifications

- Voltage 6V-36V Multivoltage
- Amperage 10A@12V, 5A@24V
- Dimensions H 82 x D 22 x W 32

### Part Numbers

- M606BX Boxed



## SPST Off/On Screw Push Pull Button Switch

M628BX

### Features

- 2 Screw terminals, Brass Push Pull
- Copper alloy contacts, dia 22.3mm
- Chrome plated brass knob and face nut
- Suits panel thickness up to 15.87mm

### Specifications

- Voltage 6V-36V Multivoltage
- Amperage 10A@12V, 5A@24V
- Dimensions H 68 x D 22 x W 31

### Part Numbers

- M628BX Boxed



## SPST On/Mom Off Screw Push Button Switch

9115BX

### Features

- Spring return to On
- Normally On, chrome button
- 2 screw terminals (with lock washers)
- Stem 5/8"-32, L 22.3mm, dia 16mm
- Suits panel thickness 12.7mm

### Specifications

- Voltage 6V-36V Multivoltage
- Amperage 10A@12V, 5A@24V
- Dimensions H 33 x D 51 x W 23

### Part Numbers

- 9115BX Boxed

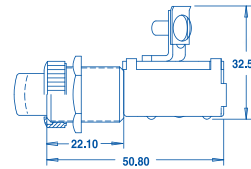

## SPST Off/Mom On Screw Push Button Switch

9095BX

### Features

- Spring return to Off
- 2 screw terminals, silver contacts
- Mounting stem 5/8"-32, Length 16mm
- Suits panel thickness 6.35mm -16mm

### Specifications

- Voltage 6V-36V Multivoltage
- Amperage 35A@12V, 20A@24V
- Dimensions H 58 x Ø 28

### Part Numbers

- 9095BX Boxed

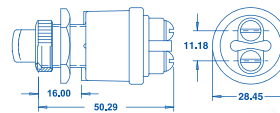

## SPST Off/Mom On Push Button Switch

96101BX

### Features

- Spring return to Off
- 2 screw terminals
- Copper alloy contacts
- Black button, flange mount

### Specifications

- Voltage 6V-36V Multivoltage
- Amperage 10A@12V, 5A@24V
- Dimensions H 56 x D 26 x W 30

### Part Numbers

- 96101BX Boxed

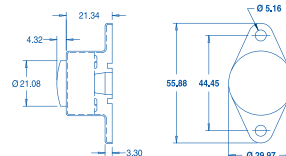





# Rotary

---

# Switches

# ROTARY SWITCHES

## Rotary Switches

Rotary switches are usually used for special purpose applications including headlamp and windscreen wiper operation.

The Cole Hersee range features models which can be used for more common applications.



### Windscreen Wiper Washer Off/Park/Lo/Hi

75221-09B

#### Features

- Without dynamic parking
- 5 blade terminals
- 6A internal circuit breaker
- Push to wash, white imprint
- Mounting stem thread 7/16"-28
- Mounting stem length 9.6mm

#### Specifications

- Voltage 12/24V Dual voltage
- Amperage 6A@12V, 3A@24V
- Dimensions H 61 x Ø 41

#### Part Numbers

- 75221-09B Boxed



### Windscreen Wiper Washer Off/Park/Lo/Hi

75228-03BX

#### Features

- For dynamic parking motors, single motor
- 6 blade terminals
- Push to wash, white imprint
- O-ring sealed shaft
- Mounting stem 7/16"-28 thread
- Mounting stem length 11.43mm

#### Specifications

- Voltage 12/24V Dual voltage
- Amperage 6A@12V, 3A@24V
- Dimensions H 61 x D 41

#### Part Numbers

- 75228-03BX Boxed

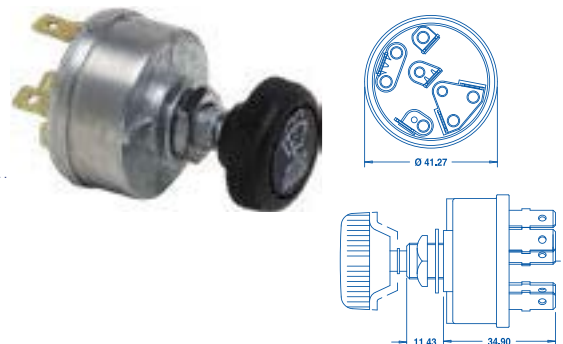

## DPDT Reversing Mom On/Off/Mom On

75712-04BX

Heavy duty 50A switch allows forward and reverse motion of a motor without the need for a relay, especially for operation of tarps on trucks.

### Features

- 4 Screw terminals, silver contacts
- Mounting stem 1/2"-20
- Terminal screws 10-32 / 9.5mm
- Forward and reverse control of motors

### Specifications

- Voltage 6V-36V Multivoltage
- Amperage 50A@12V, 30A@24V
- Dimensions H 69 x Ø 53

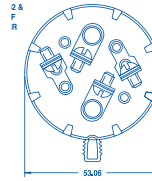

### Part Numbers

- 75712-04BX Boxed

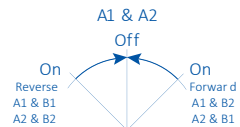

Both positions spring return to OFF position

A1 & A2 circuits must break before another circuit makes

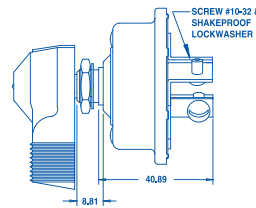

## SPST Off/On Round Knob Rotary Switch

72150-01B

### Features

- Compact durable nylon body, knob and stem, IP53
- Aluminium hardware, plated brass blade terminals

### Specifications

- Voltage 6V-24V Multivoltage
- Amperage 10A@12V, 5A@24V
- Dimensions H 30 x D 52 x W 30

### Part Numbers

- 72150-01B Boxed



## SPDT Off/On/On Round Knob Rotary Switch

72171-02BX

### Features

- Compact durable nylon body, knob and stem, IP53
- Aluminium hardware, plated brass blade terminals

### Specifications

- Voltage 6V-24V Multivoltage
- Amperage 10A@12V, 5A@24V
- Dimensions H 30 x D 52 x W 30

### Part Numbers

- 72171-02BX Boxed



## Windscreen Wiper Washer Electronic 12V

75600-02BX

### Features

- Pre-wired single motor control
- Silver contacts, heavy duty
- Mounting stem 7/16"-28 thread, L 11.4mm
- Suits system with or without dynamic park
- Approvals; SAE J1455, J112a, J234

### Specifications

- Voltage 12V
- Amperage 6A@12V
- Dimensions H 47 x D 56 x W 56

### Part Numbers

- 75600-02BX Boxed

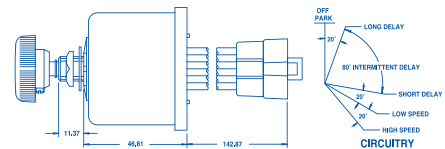

## Windscreen Wiper Washer Electronic 24V

75602-04BX

### Features

- Single motor control
- Silver contacts, heavy duty
- Mounting stem 7/16"-28 thread, L 11.4mm
- Suits system with or without dynamic park
- Variable speed intermittent function
- Approvals; SAE J1455, J112a, J234

### Specifications

- Voltage 24V
- Amperage 3A@24V
- Dimensions H 47 x D 56 x W 56

### Part Numbers

- 75602-04BX Boxed

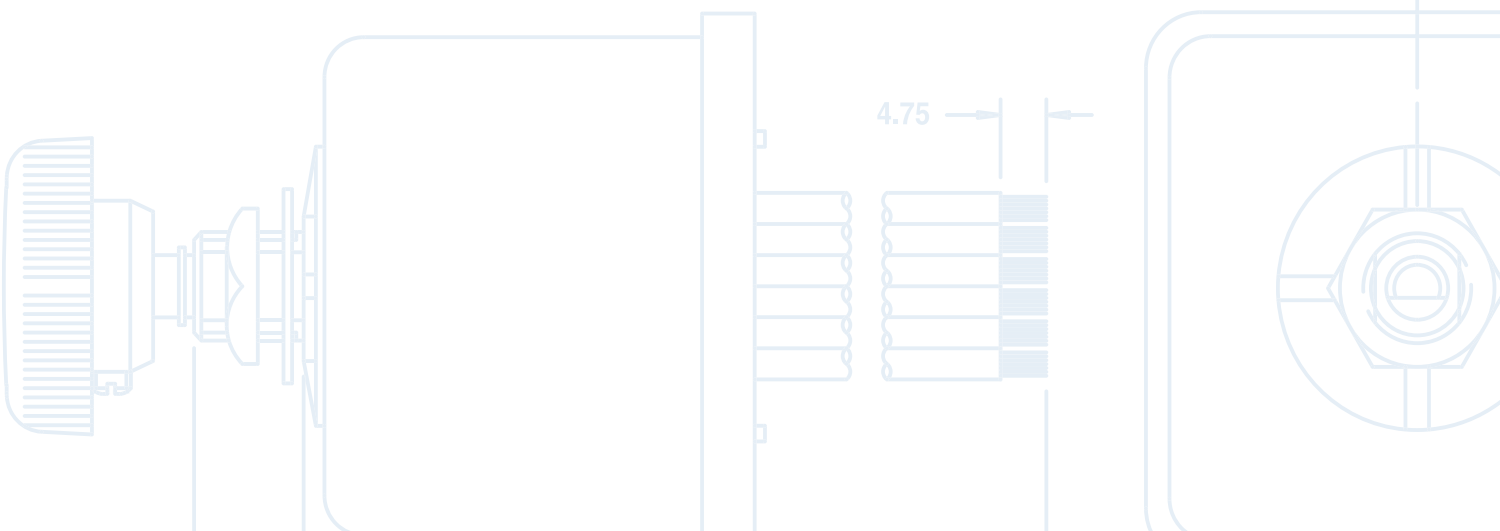
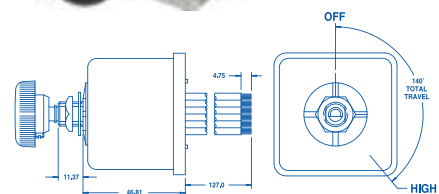



# Ignition Switches

Ignition Switches are usually operated by a coded key and tumbler lock, hencol keyed lock or lever. Lever design is available in three different configurations: short, long and military. Ignition Switches are available with coded cylinder locks and keys or hencol non-tumbler locks with compatible keys.

Switches are available with a grounded case design with a separate ground terminal. A grounded case switch must be installed in a metal panel which is part of the vehicle earthing system. In non-grounded panels, select a switch with an earth terminal.

For applications subject to adverse environmental conditions a switch can be furnished with an O-ring seal in the bushing and a gasket seal to protect the terminal insulator. As an added feature Cole Hersee manufactures weather resistant rubber boot and mounting assemblies, and protective caps.

Two, three and four position circuitry is available for battery ignition and magneto switches. Combination circuits include: earth, accessory, lighting, diesel glow plug, and anti-restart options. Standard configurations include spring return from one or two positions.

Screw terminals are equipped with lockwashers to assure efficient connection of circuit wire. Blade terminals are brass, 1/4" wide arranged to accept multi-pole connectors.



Key removable in Off position only, spring return to Ign/Acc position.



Key removable in Off position only, spring return to Ign/Acc position, spring return to Off from Fuel.



Key removable in Off position only, spring return to Ign position.

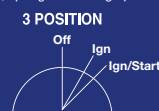

Spring return to Off position from Glow and Glow/Start.

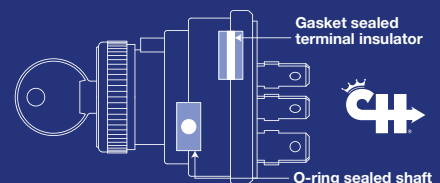

Gasket sealed terminal insulator



O-ring sealed shaft

# IGNITION SWITCHES

## Anti-Restart 4 Position Sealed Ignition Switch

95060-01BX

This sealed switch from Cole Hersee is constructed from engineered thermoplastic and is OEM quality.

A fully sealed O-ring, ultrasonic welding and integral Deutsch connector, this switch is rated to IP67. Supplied with two matching keys including integrated boots.

### Features

- Engineered thermoplastic, OEM quality
- Fully sealed O-ring, ultrasonic welding
- Integral Deutsch connector, IP67
- Selectable switching and key options
- Multiple key codes or keyed alike option
- Supplied with 2 matching keys
- Plastic face nut and nickel plated back nut
- Key removable only in Off position
- Spring return to Ign/Acc position
- Ideal for agricultural, earthmoving and mining

### Specifications

- Voltage 6V-24V Multivoltage
- Amperage 10A@12V, 5A@24V
- Dimensions H 72 x Ø 51
- Modes Acc/Off/Ign/Start (anti-restart)
- Application Heavy Duty, Mining, Marine, Key Start



### Part Numbers

- 95060-01BX Boxed

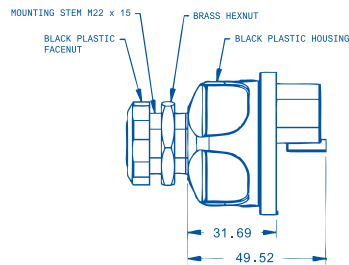
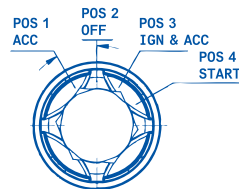

## 4 Position Heavy Duty Ignition Switch

9579BX

### Features

- 4 Screw terminals, bronze contacts
- Heavy duty, coded key actuator
- Key removable in Off position only
- Mounting stem 3/4" – 20 bush
- Panel thickness 1.52mm to 9.52mm

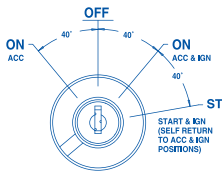

### Specifications

- Voltage 12V
- Amperage 10A@12V accessory, 10A@12V ignition, 10A@12V start
- Dimensions H 60 x Ø 37
- Modes Acc/Off/Ign Acc/Ign
- Application Heavy Duty, Mining, Key Start

### Part Numbers

- 9579BX Boxed





## Marine 3 Position Ignition Off/Ign/Ign Start

M850BX

### Features

- Push for choke, coded key actuator
- Impact resistant plastic body
- 3 Screw terminals, nickel silver contacts
- Individual key codes for added security
- Long stem suits panel up to 33mm thick

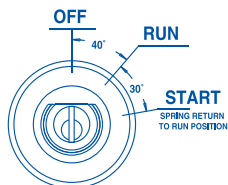

### Specifications

- Voltage 6V-36V Multivoltage
- Amperage 15A@6-36V ignition, 20A@6-36V start
- Dimensions H 72 x Ø 38

### Part Numbers

- M850BX Boxed



## Marine 3 Position Ignition Switch Off/Ign/Ign Start

M550BX

### Features

- Heavy duty, 3 brass screw terminals
- Brass case and hardware, coded key actuator
- Key removable in Off position only
- Mounting stem 13/16"-24 bush
- Mounting stem length 30.95mm
- Panel thickness up to 25.40mm

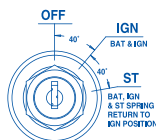
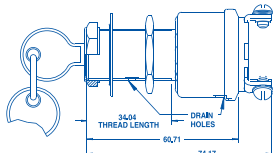

### Specifications

- Voltage 12V
- Amperage 10A@12V ignition, 5A@12V start
- Dimensions H 74 x Ø 37

### Part Numbers

- M550BX Boxed



## Anti-Restart Ignition Switch Off/On/Ign Start

956-3125BX

### Features

- 4 Screw terminals, Copper contacts
- O-ring sealed housing, keyed actuator
- Will not restart unless returned to Off position
- Key removable in Off position only
- Mounting stem 1"-24 bush
- Panel thickness 0.76mm to 2.85mm

### Specifications

- Voltage 12V
- Amperage 30A@12V accessory, 10A@12V ignition, 10A@12V start
- Dimensions H 65 x Ø 47

### Part Numbers

- 956-3125BX Boxed

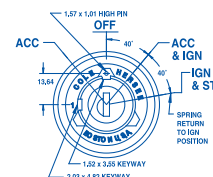
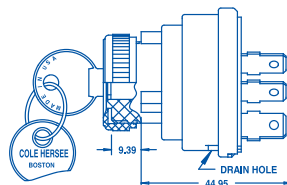

## Anti-Restart Ignition Switch Off/Ign/Start

956-3124BX

### Features

- 4 Screw terminals, Copper contacts
- O-ring sealed housing, keyed actuator
- Will not restart unless returned to Off position
- Mounting stem 1"-24 bush
- Panel thickness 0.76mm to 2.85mm

### Specifications

- Voltage 12V
- Amperage 10A@12V accessory, 10A@12V ignition, 10A@12V start
- Dimensions H 78 x Ø 46

### Part Numbers

- 956-3124BX Boxed

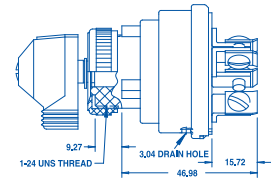
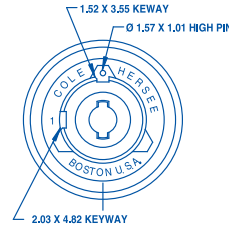

## Universal Ignition Switch Off/Ign/Start

95612BX

### Features

- 3 Screw terminals, silver contacts
- O-ring sealed housing, lever actuator
- Mounting stem 5/8"-32
- Panel thickness 1.52mm to 6.65mm

### Specifications

- Voltage 6V-36V Multivoltage
- Amperage 25A@12V ignition, 20A@12V start
- Dimensions H 81 x Ø 37

### Part Numbers

- 95612BX Boxed

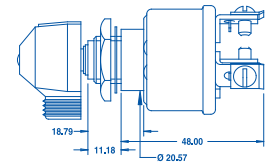
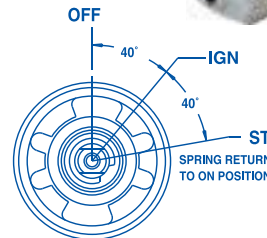

## Diesel Ignition Switch 3 Position Glow/Off/Glow Start

95033BX

This heavy duty switch provides a superior pre-heat circuit to energize the glow pins.

### Features

- 3 Screw terminals, silver contacts
- O-ring sealed housing, Lever actuator
- Mounting stem 5/8"-32
- Panel thickness 1.52mm to 6.65mm

### Specifications

- Voltage 6V-36V Multivoltage
- Amperage 50A@12V ignition, run glow, 5A@12V start
- Dimensions H 81 x Ø 37

### Part Numbers

- 95033BX Boxed

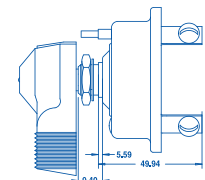
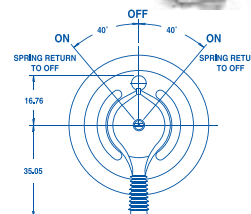



# Solenoids

---



# SOLENOIDS

**A Solenoid is an electromagnetic relay used in a direct current wiring system between a low current capacity switch and a high current load requirement. In an engine starting system, the ignition switch in the start position may have a rating of 5 amps whilst the starter motor may have a cranking requirement of 200 to 350 amps.**

Once energised by the Ignition Switch, the Solenoid coil moves the high current capacity contact to a closed position, thereby energising the starter motor.

When equipment is started, the intermittent starter application is used for only a few seconds during each start. To meet this short term demand, an Intermittent Solenoid is used to carry the high rating of current. However, the Solenoid will overheat and fail, as would the starter motor, if the starter were to run continuously.

For periods up to 15 seconds, it is constructed so it can be energised without overheating and destroying its windings.

Rated much lower, the Continuous Solenoid will not overheat in continuous operation. Used for such applications as accessory circuits and lifts—where there is uninterrupted operation—a Continuous Duty Solenoid is constructed so it can be energised constantly without its windings.

As the demands placed upon vehicle electrical systems continue to increase, the electrical system components must be able to handle higher loads.

Numerous applications require a Solenoid, listed below are just a few:

- Farm equipment
- Emergency vehicles
- Golf carts
- Hoists
- Buses
- Industrial equipment
- Construction equipment
- Tailgates
- Trucks
- Lift trucks
- Tractors

## Conservative Electrical Ratings for Solenoids

### Intermittent Duty Solenoids

SPST 6–12 volts DC  
750 amp make  
100 amp break  
10 seconds On, 20 minutes Off

### Intermittent Duty Solenoids

SPST 6–36 volts DC  
120 amp make  
65 amp break  
10 seconds On, 30 minutes Off

### Continuous Duty Solenoids

SPST 24–36 volts DC  
85 amp make

### Continuous Duty Solenoids: SPDT

35 amp: front studs, normally closed  
85 amp: side studs, normally open

## Cole Hersee Solenoids

- Intermittent Duty Solenoids: SPST, steel housing, normally open contacts, one circuit: Off/On
- Intermittent Duty Solenoids: SPST, phenolic housing, normally open contacts, one circuit: Off/On
- Intermittent Duty Solenoids: SPST, plasticised steel housing, normally open contacts, one circuit: Off/On
- Continuous Duty Solenoids: SPST, steel housing, normally open contacts, one circuit: Off/On
- Continuous Duty Solenoids: SPST, steel housing, normally closed contacts
- Continuous Duty Solenoids: SPST, steel housing, normally open and closed contacts
- Continuous Duty Solenoids: SPST, plasticised steel housing, normally open contacts, one circuit: Off/On
- Continuous Duty Latching Solenoids: carry only

Please note: some of the above mentioned options may not be shown in this catalogue.



## SPST Continuous Duty Solenoid

24059BX

A Solenoid is an electromagnetic relay used in a direct current wiring system between a low current capacity switch and a high current load requirement.

### Features

- 4 Stud, Insulated stud earth
- SPST Normally open (one circuit) Off/On
- Copper Stud terminals 5/16"-24
- Insulated Coil terminals 10-32
- Strong plated steel housing
- Plated steel nuts and washers included
- Mounting holes; 8mm x 15mm, 56mm CTC
- Mount with brand cap facing down
- Int. ratings: 10 sec On, 30 min Off

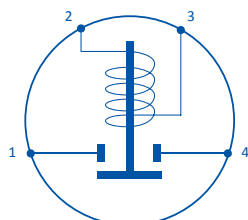

### Specifications

- Voltage 12V, 24V, 36V Models
- Dimensions H 60 x D 64 x W 84
- Configuration SPST
- Modes Off/On
- Application Heavy Duty, Mining

### Part Numbers 12V, 17.5 ohm

- 24059BX 85A Continuous  
750A Make  
100A Break

### Part Numbers 24V, 71 ohm

- 24063BX 85A Continuous  
120A Make  
100A Break
- 24144BX 200A Continuous  
150A Make  
150A Break

### Part Numbers 36V, 130 ohm

- 24080BX 85A Continuous  
120A Make  
65A Break

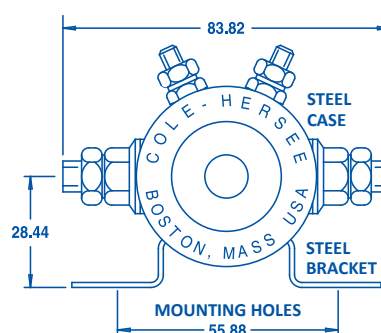

## SPST Continuous Duty Insulated Earth PVC Coated

M24117BX

A Solenoid is an electromagnetic relay used in a direct current wiring system between a low current capacity switch and a high current load requirement.

Weatherproof PVC coated housing versions are UL listed and ISO 8846 Marine grade.

### Features

- 4 Stud, Insulated stud earth
- SPST Normally open (one circuit) Off/On
- Copper Stud terminals 5/16"-24
- Insulated Coil terminals 10-32
- Strong plated steel housing
- Plated steel nuts and washers included
- Mounting holes; 8mm x 15mm, 56mm CTC
- Mount with brand cap facing down
- Int. ratings: 10 sec On, 30 min Off

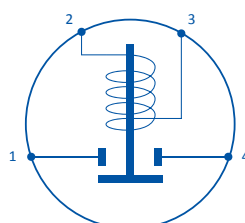

### Specifications

- Voltage 12V, 24V, 36V Models
- Dimensions H 60 x D 64 x W 84
- Configuration SPST
- Modes Off/On
- Application Heavy Duty, Marine

### Part Numbers 12V, 17.5 ohm

- M24117BX 85A Continuous  
750A Make  
100A Break

### Part Numbers 24V, 71 ohm

- 24063BX 85A Continuous  
120A Make  
100A Break



## SPST Continuous 12V 110A Latching Solenoid

24200BX

### Features

- Pulse energise, stays on; pulse again, drops out.
- No heat generated due to coil taken out of circuit
- Copper Stud terminals 5/16"-24
- Insulated Coil terminals 10-32
- Strong plated steel housing
- Plated steel nuts and washers included
- Mounting holes 8mm x 15mm, 56mm CTC
- Mount with brand cap facing down
- Int. ratings: 10 sec On, 30 min Off

This special Solenoid toggles On and Off, and requires no current to maintain the continuity of the power circuit. Use it with a Mom function switch. Actuation of the momentary switch causes current to flow in the solenoid coil, locking the contact in place, maintaining the load circuit in an On position. A second actuation of the momentary switch releases the plunger, turning the load circuit Off.

Suggested to be used with momentary switches.

### Specifications

- Voltage 12V
- Dimensions H 60 x D 79 x W 84
- Configuration SPST
- Application Heavy Duty, Mining

### Part Numbers

- 24200BX 110A Continuous  
110A (carry only)

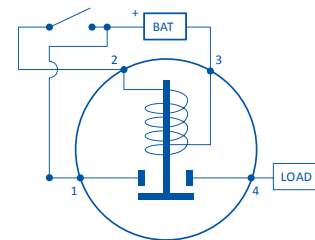

### Remote Battery Isolator

In a two-battery system, use the Latching Solenoid to isolate the batteries from each other, and prevent battery drain from the higher into the lower. It has an advantage over electronic Battery Isolators, in that it will not produce a voltage drop during operation.

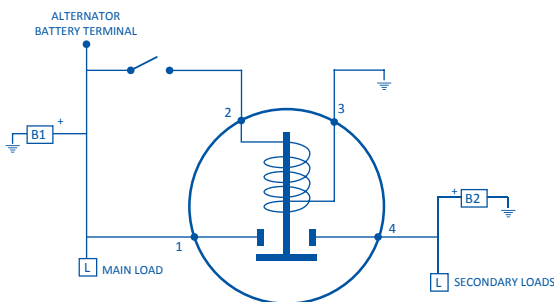

### Remote Battery Disconnect

Use it as a remote Battery Disconnect Switch. This eliminates the need for heavy gauge wiring between the control panel and the battery.

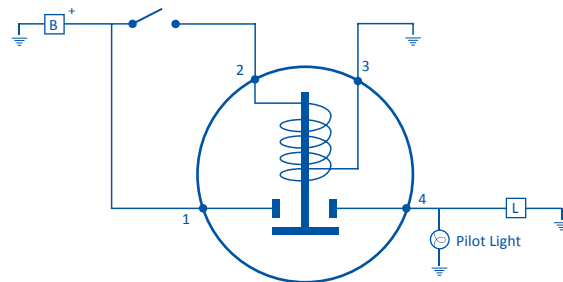

## SPST Intermittent Duty Solenoid

24037BX

### Features

- 3 Stud, Grounded stud earth
- SPST Normally open (one circuit) Off/On
- Copper Stud terminals 5/16"-24
- Internal grounded, Coil terminals 10-32
- Strong plated steel housing
- Plated steel nuts and washers included
- Mounting holes; 8mm x 15mm, 56mm CTC
- Mount with brand cap facing down
- Int. ratings: 10 sec On, 20 min Off

### Specifications

- Voltage 12V, 24V, 36V Models
- Dimensions H 60 x D 64 x W 84
- Configuration SPST
- Modes Off/On
- Application Heavy Duty, Mining

### Part Numbers 12V, 4.4 ohm

- 24037BX 750A Make  
100A Break

### Part Numbers 24V, 29 ohm

- 24063BX 375A Make  
100A Break

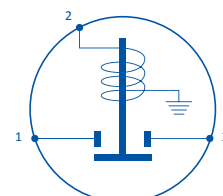



## SPST Intermittent Duty Solenoid

**M200BX**

A Solenoid is an electromagnetic relay used in a direct current wiring system between a low current capacity switch and a high current load requirement.

### Features

- 4 Stud, Insulated stud earth
- SPST Normally open (one circuit) Off/On
- Copper Stud terminals 5/16"-24
- Insulated Coil terminals 10-32
- Strong plated steel housing
- Plated steel nuts and washers included
- Mounting holes; 8mm x 15mm, 56mm CTC
- Mount with brand cap facing down
- Int. ratings: 10 sec On, 20 min Off

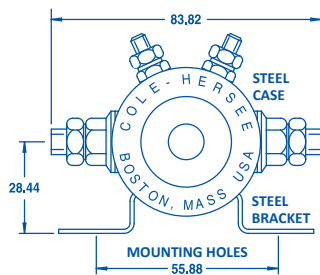

### Specifications

- Voltage 12V, 24V Models
- Dimensions H 60 x D 64 x W 84
- Configuration SPST
- Modes Off/On
- Application Heavy Duty, Mining

### Part Numbers 12V, 4.4 ohm

- M200BX 750A Make  
100A Break  
clear protective coating

### Part Numbers 24V, 29 ohm

- 24008BX 120A Make  
65A Break

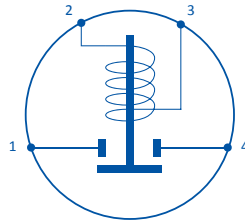

Marine, clear protective coating finish, M200BX

## DPDT Twin Motor Reversing Intermittent Solenoid

**24450BX**

For reversing motors such as hoists, winches, ATVs and snowplow blades.

Two Solenoids in one for cost and space savings and simpler wiring. Two Integral Solenoids provide dynamic braking for permanent magnet motors when neither coil is energised.

### Features

- F bracket, copper contacts
- Coil terminal blades, common ground
- Two blade coil terminals 5/16"-24
- Black nylon housing, nuts & washers
- Strong black nylon housing
- Plated steel nuts and washers included
- Mounting holes, 105mm CTC

### Specifications

- Voltage 12V, 24V Models
- Amperage 75A@12V, 45A@24V
- Dimensions H 76 x D 83 x W 127
- Configuration DPST
- Modes Intermittent Duty

### Part Numbers 12V

- 24450BX Boxed

### Part Numbers 24V

- 24450-02BX Boxed

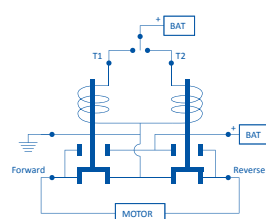
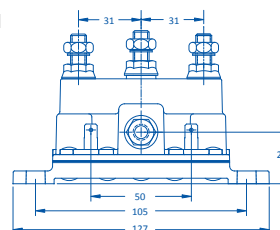

## DPST Two Circuit Change Over Solenoid

24401BX

This Solenoid can be used for special application like forward and reverse systems in electric golf carts, garden tractors, fork lifts, trucks, winches, etc.

### Features

- Normally open and normally closed contacts
- Used for forward and reverse systems
- Copper Stud terminals 5/16"-24
- Insulated Coil terminals 10-32
- Strong plated steel housing
- Plated steel nuts and washers included
- Mounting holes; 8mm x 15mm, 56mm CTC
- Int. ratings: 10 sec On, 30 min Off

### Specifications

- Voltage 12V, 24V Models
- Amperage 35A Normally Closed, 85A Normally Open Continuous
- Dimensions H 60 x D 64 x W 84
- Configuration DPST
- Modes Continuous Duty
- Application Heavy Duty, Mining

### Part Numbers 12V, 17.5 ohm

- 24401BX Boxed

### Part Numbers 24V, 71 ohm

- 24402BX Boxed

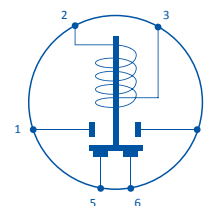
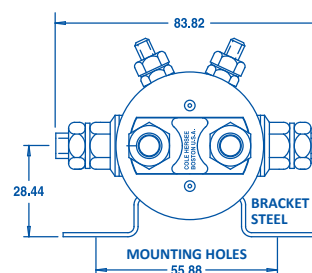

### Motor Reversing Solenoid Wiring Diagram

Typical DC series wound permanent magnet circuit, using a pair of double-action Solenoids. Use pairs of the following Solenoids: 24401 (12V) or 24402 (24V).

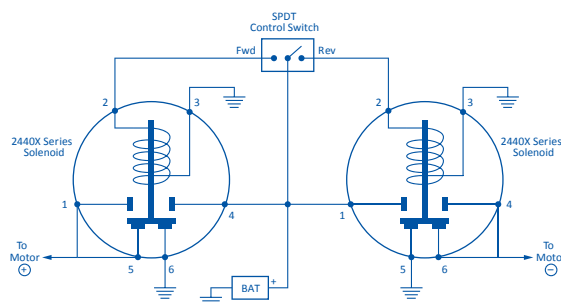

## Twin Motor Forward & Reverse Relay Solenoid

24452BX

### Features

- Dynamic braking when switch turned Off
- Heavy load current, dielectric strength 500V RMS
- Studs are securely protected in epoxy
- Low profile module (less than H 50mm)
- Fully sealed for harsh environment
- Rust and moisture resistant housing
- Tin plated brass studs, vibration resistance: 10-55Hz
- For intermittent operation use switch: Mom On/Off/Mom On
- For continuous use switch: On/Off/On
- Ideal for tarp, hoist, winch, fans and other motor reversing applications
- Automatically reverses the direction of motors

Reversing module carries a heavy load and is suitable for intermittent or continuous operation at 12 VDC.

Ideal for tarp or lift applications as well as for hoists, hatches, winches/ windlasses, snowplows, intake/exhaust fans, vehicle outriggers and many other direction reversing applications.

### Specifications

- Voltage 12V
- Dimensions H 48 x D 74 x W 92
- Configuration SPST
- Modes Off/On
- Application Heavy Duty, Mining

### Part Numbers

- 24452BX Boxed

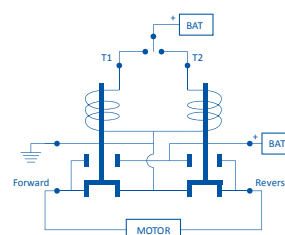

## SPST 225A Heavy Duty Solenoid Continuous

24812BX

For use with heavy vehicles, materials handling, hydraulic systems, large DC machinery, and electric vehicles.

### Features

- SPST Normally open (one circuit) Off/On
- Copper Stud terminals 5/16"-24
- Insulated Coil terminals 10-32, L bracket
- Strong plated steel housing
- Plated steel nuts and washers included
- Mounting holes 8mm x 15mm, 56mm CTC
- Int. ratings: 10 sec Of, 30 min Off

### Specifications

- Voltage 12V, 24V Models
- Dimensions H 103 x D 69 x W 100
- Configuration SPST
- Modes Continuous Duty
- Application Heavy Duty

### Part Numbers 12V, 7.7 ohm

- 24812BX 225A Continuous  
750A Make  
150A Break

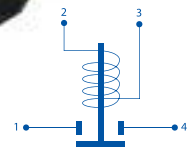

## SPST 12V 100A Continuous Nylon Solenoid

24612-10BX

### Features

- SPST Normally open (one circuit) Off/On
- 4 Stud, Copper Stud terminals 5/16"-24
- Insulated coil terminal 10-32
- Glass black nylon housing, F bracket
- Plated steel nuts and washers included
- Mounting holes 8mm x 15mm, 56mm CTC
- Int. ratings: 10 sec On, 30 min Off

### Specifications

- Voltage 24V
- Amperage 100A Continuous  
400A Inrush  
100A Make and Break
- Dimensions H 65 x D 47 x W 76

### Part Numbers

- 24612-10BX 12V, 16 ohm

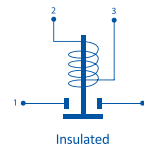

## SPST 24V 100A Continuous Nylon Solenoid

24624-10BX

### Features

- SPST Normally open (one circuit) Off/On
- 4 Stud, Copper Stud terminals 5/16"-24
- Insulated coil terminal 10-32
- Glass black nylon housing, F bracket
- Plated steel nuts and washers included
- Mounting holes 8mm x 15mm, 56mm CTC
- Int. ratings: 10 sec On, 30 min Off

### Specifications

- Voltage 24V
- Amperage 100A Continuous  
200A Inrush  
100A Make and Break
- Dimensions H 65 x D 47 x W 76

### Part Numbers

- 24624-10BX 24V, 64 ohm

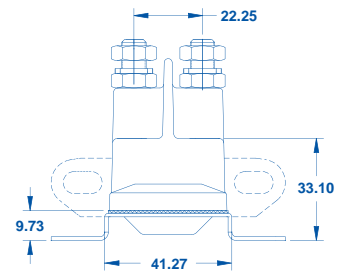
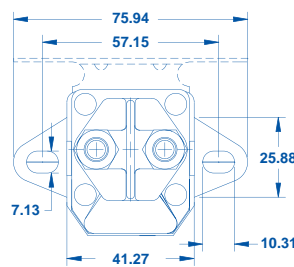
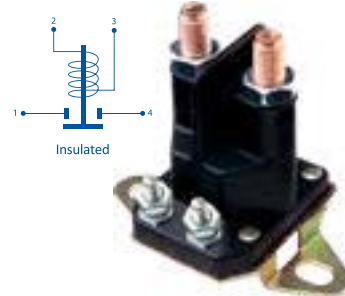

## SPST 12V 100A Continuous Nylon Solenoid

24512-10BX

### Features

- SPST Normally open (one circuit) Off/On
- 2 Blade, 2 Stud, Copper Stud terminals 5/16"-24
- Insulated coil terminal 10-32
- Glass black nylon housing, F bracket
- Plated steel nuts and washers included
- Mounting holes 8mm x 15mm, 56mm CTC
- Int. ratings: 10 sec On, 30 min Off

### Specifications

- Voltage 12V
- Amperage 100A Continuous  
400A Inrush  
100A Make and Break
- Dimensions H 65 x D 47 x W 76

### Part Numbers

- 24512-10BX Boxed

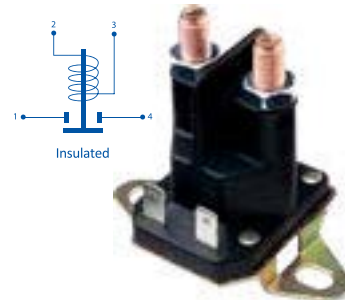

## SPST 12V 100A Continuous Nylon Solenoid

24612BX

### Features

- SPST Normally open (one circuit) Off/On
- 4 Stud, Copper Stud terminals 5/16"-24
- Insulated coil terminal 10-32
- Glass black nylon housing, L bracket
- Plated steel nuts and washers included
- Mounting holes 8mm x 15mm, 56mm CTC
- Int. ratings: 10 sec On, 30 min Off

### Specifications

- Voltage 12V
- 24059BX 100A Continuous  
400A Inrush  
100A Make and Break
- Dimensions H 65 x D 47 x W 76

### Part Numbers

- 24612BX Boxed

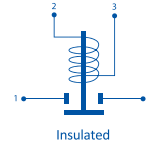

## SPST 12V 200A Intermittent Nylon Solenoid

24512-03BX

### Features

- SPST Normally open (one circuit) Off/On
- 2 Blade, 2 Stud, Copper Stud terminals 5/16"-24
- Insulated coil terminal 10-32
- Glass black nylon housing, L bracket
- Plated steel nuts and washers included
- Mounting holes 8mm x 15mm, 56mm CTC
- Int. ratings: 20 sec On, 40 min Off

### Specifications

- Voltage 12V
- Amperage 200A Intermittent  
500A Inrush  
200A Make and Break
- Dimensions H 65 x D 47 x W 76

### Part Numbers

- 24512-03BX Boxed

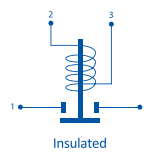

## SPST 12V 200A Intermittent Nylon Solenoid

24612-03BX

### Features

- SPST Normally open (one circuit) Off/On
- 4 Stud, Copper Stud terminals 5/16"-24
- Insulated coil terminal 10-32
- Glass black nylon housing, L bracket
- Plated steel nuts and washers included
- Mounting holes 8mm x 15mm, 56mm CTC
- Int. ratings: 20 sec On, 40 min Off

### Specifications

- Voltage 12V
- Amperage 200A Intermittent  
500A Inrush  
200A Make and Break
- Dimensions H 65 x D 47 x W 76

### Part Numbers

- 24612-03BX Boxed

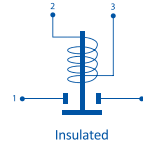

## SPST 12V 200A Intermittent Nylon Solenoid

24612-13BX

### Features

- SPST Normally open (one circuit) Off/On
- 2 Blade, 2 Stud, Copper Stud terminals 5/16"-24
- Insulated coil terminal 10-32
- Glass black nylon housing, F bracket
- Plated steel nuts and washers included
- Mounting holes 8mm x 15mm, 56mm CTC
- Int. ratings: 20 sec On, 40 min Off

### Specifications

- Voltage 12V
- Amperage 200A Intermittent  
500A Inrush  
200A Make and Break
- Dimensions H 65 x D 47 x W 76

### Part Numbers

- 24612-13BBX Boxed

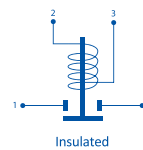



# Circuit Breakers

---



# CIRCUIT BREAKERS

**Cole Hersee Circuit Breakers and compatible Mounting Brackets are designed and engineered for responsive performance over a long period. Casings are manufactured from either high quality plated steel or durable plastic. Mounting Brackets are available in heavy gauge steel or lightweight moulded plastic.**

All electrical circuits need protection so an overload condition can be detected and the circuit opened until the overload can be corrected. The inexpensive protection of a Circuit Breaker can save the failure of an expensive piece of equipment or an even greater loss due to an electrical fire.

Generation of heat is a result of an electrical overload. A fuse has a metal element which is designed to melt and open the circuit at a relatively low heat. Two different elements of metals are used in a Circuit Breaker. The elements bend and separate due to heat, thus opening the circuit. A melted fuse must be replaced, but a Circuit Breaker can continue to function after the cause of the overload is corrected.

Most electrical systems have numerous circuits: each circuit can be operated independently, therefore each circuit needs protection. With direct current circuits in a battery powered vehicle, circuit protection is very important. The cost of an engine starter or other equipment in a car or truck compared to the cost of a Circuit Breaker, makes the Circuit Breaker an obvious and necessary addition.

Circuit Breakers are the choice for protection in heavy duty vehicles and equipment. There are more than 20 types of Circuit Breakers to fit the requirements of both equipment design engineers and aftermarket replacement—suitable for vehicles on and off the road, equipment in the field and the construction site.

## SAE J553 Circuit Breaker Types

**Type I:** Automatic: Cycle or continuously reset until the overload is corrected.

**Type II:** Remains open as long as the overload exists, the unit resets when the situation is corrected.

**Type III:** Manual: Remains open until the unit is manually reset by pushing a button.

## Circuit Breaker Type Options

### Type I

- 12 volt, steel housing, bracket along case
- 12 volt, steel housing, snap-in mounting
- 12 volt, steel housing, plug-in mounting
- 24 volt, steel housing, bracket along case
- 24 volt, steel housing, snap-in mounting
- 12 volt, steel housing, dual circuit breaker, bracket along case
- 12 volt, plastic housing, bracket along case
- 12 volt, plasticised housing, no bracket
- 12 volt, plasticised housing, bracket along case

### Type II

- 12 volt, steel housing, bracket along case
- 12 volt, steel housing, snap-in mounting
- 12 volt, plastic housing, plug-in mounting
- 12 volt, plastic housing, fuse clip snap-in mounting

### Type III

- 12 volt, plastic housing, bracket along case
- 12 volt, plastic housing, snap-in mounting

Please note: some of the above mentioned options may not be shown in this catalogue.

## Metal or Plastic Body?

There's not a lot of difference between metal body and plastic body circuit breakers: both are about the same weight and structural integrity, but the plastic type is more resistant to denting and corrosion. One type of plastic-body breaker, the 30427 series, is also weather-resistant.

# SAE J553 FOR CIRCUIT BREAKERS

Society of Automotive Engineers Standard J553 defines testing and performance requirements for three types of Circuit Breakers up to 50A for 6V, 12V, and 24V operation: Type I, Type II, and Type III.

## Conforming Circuit Breakers

- Must carry 100% of rated current continuously for a minimum of one hour
- Must open at 135% of rated current within 30 minutes
- Must open at 200% of rated current within one minute

The specific current capacity of the Circuit Breaker is a function of the particular electrical system being utilised. It is recommended that the actual performance be verified through testing experimentally in the proposed application.

Several factors should be considered:

### Wire and Terminations

The connecting wires and their terminations will affect the heat dissipation characteristic of the breakers. Deviations from the breaker application specifications may affect the current carrying capacity or the effective limitation of current during overload cycling.

### Voltage Rating

The rating marked on breakers is the maximum value recommended. Use at higher voltages may significantly shorten product life under load conditions, and possibly cause damage to your equipment.

### Circuit Protection

Components are thermal devices that create an open circuit under overcurrent conditions. They are deliberately designed as the sacrificial weakest link in a system, protecting components from costly damage. It is important to select a fuse or circuit breaker with a current rating equal to or lower than the lowest current rating of any part of the circuit.

### Ambient temperature

Circuit Breakers are thermal devices. Changes in the ambient temperature will have an effect on the current carrying capacity and on the effective limitation of current during overload cycling.

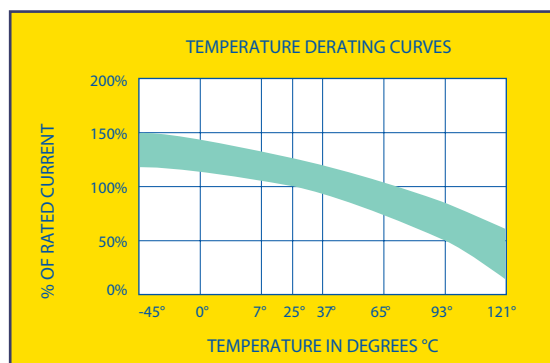
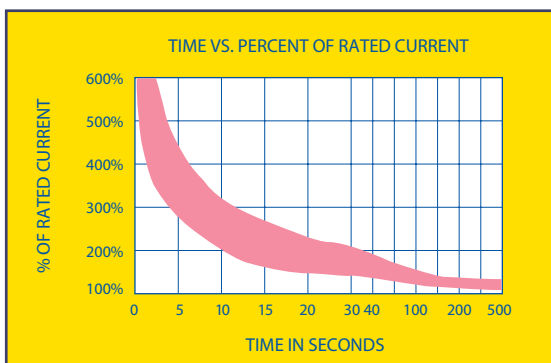

All Cole Hersee Circuit Breakers conform to SAE Standard J553.



## Metal Thermal Reset Cycling Circuit Breakers

**30055-10BX**

These metal Type I Circuit Breakers cycle or continuously reset until the overload is corrected.

### Features

- Plated steel case and mounting brackets
- Flange mount, stud terminals 10-32
- Short stud – BAT, Long stud – LOAD

### Specifications

- Voltage 12V, 24V
- Amperage 6A, 10A, 15A, 20A, 25A, 30A, 40A, 50A
- Dimensions H 31 x D 20 x W 51

### Part Numbers 12V

- 30055-10BX 10A
- 30055-15BX 15A
- 30055-20BX 20A
- 30055-25BX 25A
- 30055-30BX 30A
- 30055-40BX 40A
- 30055-50BX 50A

### Part Numbers 24V

- 30172-20B 20A



## Metal Plug In Cycling ATC/ATO Circuit Breakers

**30409-10BX**

These metal Type I Circuit Breakers cycle or continuously resets until the overload is corrected.

Terminals are grooved so that they can be easily snapped off with pliers to fit the electrical blocks of different vehicles.

Use as is long terms for Kenworth trucks.

### Features

- Plated steel case, plug in mounting
- Cut on grooves for length of terminals

### Specifications

- Voltage 12V
- Amperage 10A, 15A, 20A, 25A, 30A
- Dimensions H 19 x D 10 x W 21

### Part Numbers 12V

- 30409-10BX 10A
- 30409-15BX 15A
- 30409-20BX 20A
- 30409-25BX 25A
- 30409-30BX 30A

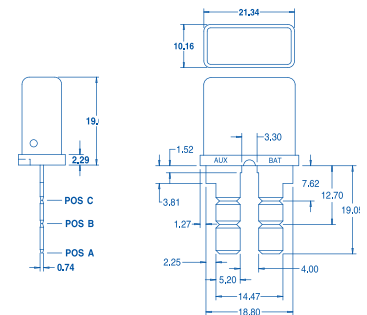

# Connectors & Electrical

The Cole Hersee range includes high quality connectors and electrical equipment such as heavy duty trailer connectors, battery studs and jumpers, headlight connectors and electronic units.

Cole Hersee trailer connectors are built to withstand the rigors of trucking thousands of kilometers in dust and dirt, heat and cold, yet maintain the all-important electrical continuity between vehicle and trailer.



## 7 Pole Trailer Connector Wiring

1	Earth return	White
2	Reversing lamp	Black
3	Left hand turn signal	Yellow
4	Stop lamps	Red
5	Right hand turn signal	Green
6	Rear, clearance, marker lamps	Brown
7	Service brakes	Blue

















**Cole Hersee®**  
A Littelfuse Brand

## Partnership

ESG Asia Pacific are currently, and have been, the exclusive Australian distributor of Cole Hersee for over 20 years!

Along with Cole Hersee, ESG Asia Pacific also distributes other well-known automotive brands including ECCO, Code 3, Britax and Xray Vision.

ESG Asia Pacific is part of the ECCO Safety Group which globally serves more than 3,000 OEM and aftermarket customers.

[www.colehersee.com.au](http://www.colehersee.com.au)



v 21.01



ESG Asia Pacific is part of the ECCO Safety Group of companies.

Britax is the registered trademark of, and is used under licence from, a member of the Britax group of companies.

**ESG Asia Pacific**  
Freecall 1800 025 921  
[eccoescg.com/au](http://eccoescg.com/au)