

Power Relay F4

- Pin assignment similar to ISO 7588 part 1
- Plug-in or PCB terminals

Customized versions on request

- 24VDC versions with contact gap >0.8mm
- 48VDC version on request
- Integrated components (e.g. resistor, diode)
- Customized marking/color
- Special covers (e.g. notches, release features, brackets)
- Various contact arrangements and materials
- For latching (bistable) version refer to Power Relay F7 A Latching
- For shrouded/weatherproof dust cover versions refer to Shrouded Power Relay F4 A and F4

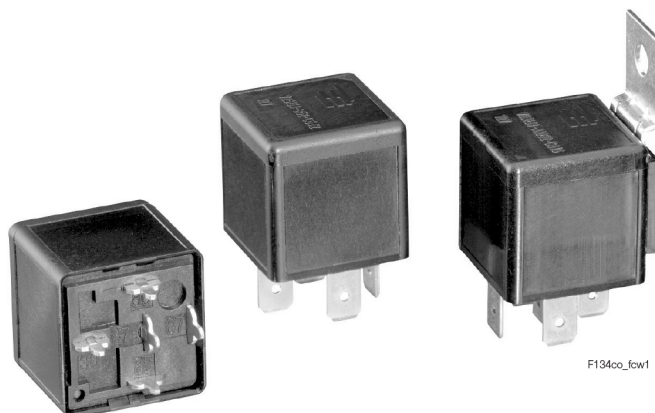

F134co_fw1

Typical applications

Cross carline up to 40A for example: ABS control, blower fans, car alarm, cooling fan, Electric Power Steering, energy management, engine control, fuel pump, heated front screen, lamps: front, rear, fog light, main switch/supply relay, valves, wiper control.

Contact Data

| Contact arrangement | 1 form A, 1 NO/1 NO (2x87) | | | 1 form U, 2 NO | | | 1 form C, 1 CO | | |
|--|---|-------------------------|-------------------------|-------------------------|-------------------------|-------------------------|-------------------------|-------------------------|-------------|
| Contact gap | | | | | | | >0.8mm | | |
| Rated voltage | 12VDC | 24VDC | 12VDC | 24VDC | 24VDC | 12VDC | 24VDC | 24VDC ¹⁾ | |
| Limiting continuous current | NO | NO | NO | NO | NO | NO/NC | NO/NC | NO/NC | |
| 23°C | 60A | 60A | 2x32A | 2x32A | 2x32A | 60/45A | 60/45A | 60/45 | |
| 85°C | 40A | 40A | 2x25A | 2x25A | 2x25A | 40/30A | 40/30A | 40/30A | |
| 125°C | 17A | 17A | 2x11A | 2x11A | 2x11A | 17/12A | 17/12A | 17/12A | |
| Limiting making current ²⁾ | | | | | | | | | |
| NO/NC | 120A | 120A | 2x100A | 2x100A | 2x100A | 120/45A | 120/45A | 120/45A | |
| Limiting breaking current | | | | | | | | | |
| NO/NC | 60A | 20A | 2x40A | 2x15A | 2x30A | 60/40A | 20/15A | 30/20 | |
| Limiting short-time current overload current, ISO 8820-3 ³⁾ : | | | | | | | | | |
| | 1.35 x 40A, 1800s | | | 1.35 x 40A, 1800s | | | 1.35 x 40A, 1800s | | |
| | 2.00 x 40A, 5s | | | 2.00 x 40A, 5s | | | 2.00 x 40A, 5s | | |
| | 3.50 x 40A, 0.5s | | | 3.50 x 40A, 0.5s | | | 3.50 x 40A, 0.5s | | |
| | 6.00 x 40A, 0.1s | | | 6.00 x 40A, 0.1s | | | 6.00 x 40A, 0.1s | | |
| Jump start test | ISO 16750-1 24VDC for 5min conducting nominal current at 23°C | | | | | | | | |
| Contact material | silver based | | | | | | | | |
| Min. recommended contact load ⁴⁾ | 1A at 5VDC | | | | | | | | |
| Initial voltage drop | | | | | | | | | |
| NO contact at 10A, typ./max. | 15/200mV | 15/200mV | 2x15/200mV | 2x15/200mV | 2x15/200mV | 15/200mV | 15/200mV | 15/200mV | |
| NC contact at 10A, typ./max. | | | | | | 20/250mV | 20/250mV | 20/250mV | |
| Frequency of operation at nominal load | 6 ops./min (0.1Hz) | | | | | | | | |
| Operate/release time typ. | 7/2ms ⁵⁾ | | | | | | | | |
| Electrical endurance ⁶⁾ | | | | | | | | | |
| resistive load, NO contact | >2x10 ⁵ ops. | >1x10 ⁵ ops. | >2x10 ⁵ ops. | >1x10 ⁵ ops. | >1x10 ⁵ ops. | >2x10 ⁵ ops. | >1x10 ⁵ ops. | >1x10 ⁵ ops. | |
| | 40A, 14VDC | 20A, 28VDC | 2x25A, 14VDC | 2x15A, 28VDC | 2x20A, 28VDC | 40A, 14VDC | 20A, 28 VDC | 30A, 28 VDC | |
| resistive load, NC contact | | | | | | | | >5x10 ⁵ ops. | 10A, 28 VDC |
| Mechanical endurance | | | | | | | | | |
| DC coil | >1x10 ⁶ ops. | | | | | | | | |

1) Special high performance 24VDC version with contact gap >0.8mm.

2) The values apply to a resistive or inductive load with suitable spark suppression and at maximum 14VDC for 12VDC or 28VDC for 24VDC load voltages. For a load current duration of maximum 3s for a make/break ratio of 1:10.

3) Current and time are compatible with circuit protection by a typical automotive fuse. Relay will make, carry and break the specified current.

4) See chapter Diagnostics of Relays in our Application Notes or consult the internet at <http://relays.te.com/appnotes/>

5) For unsuppressed relay coil. Any parallel device to the coil will increase the release time.

6) Electrical endurance data is not valid for diode versions. Any diode or pn-junction parallel to the coil (internal or external) will significantly decrease the electrical lifetime, especially when used for inductive loads.

Power Relay F4 (Continued)

Max. load DC breaking capacity

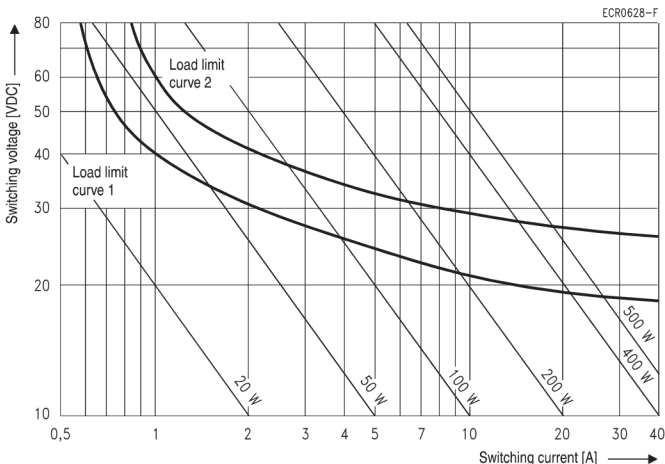

Load limit curve 1: arc extinguishes during transit time (CO contact).
 Load limit curve 2: safe shutdown, no stationary arc (NO contact).
 Load limit curves measured with low inductive resistors verified for 1000 switching events.

Coil Data

Rated coil voltage 12/24VDC

Coil versions, DC coil

| Coil code | Rated voltage VDC | Operate voltage VDC | Release voltage VDC | Coil resistance ⁷⁾ Ω±10% | Rated coil power ⁷⁾ W |
|-----------|-------------------|---------------------|---------------------|-------------------------------------|----------------------------------|
| 052 | 12 | 7.2 | 1.6 | 90 | 1.6 |
| 053 | 24 | 14.4 | 3.2 | 324 | 1.8 |
| 056 | 24 | 16.0 | 4.0 | 268 | 2.1 |
| 165 | 24 | 14.4 | 2.4 | 288 | 2.0 |

All figures are given for coil without pre-energization, at ambient temperature +23°C.

7) Without components in parallel.

Coil operating range

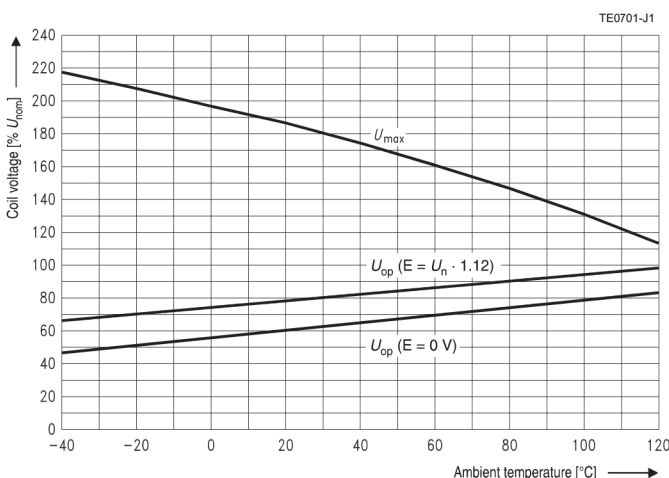

Does not take into account the temperature rise due to the contact current E=pre-energization..

Insulation Data

| | |
|----------------------------------|--------------------------|
| Initial dielectric strength | |
| between open contacts | 500V _{rms} |
| between contact and coil | 500V _{rms} |
| between adjacent contacts | 500V _{rms} |
| Load dump test | |
| ISO 7637-1 (12VDC), test pulse 5 | V _s =+86.5VDC |
| ISO 7637-2 (24VDC), test pulse 5 | V _s =+200VDC |

Other Data

| | |
|--|--|
| EU RoHS/ELV compliance | compliant |
| Ambient temperature DC coil | -40 to +125°C |
| Protection to heat and fire | UL94-HB or better ⁸⁾ |
| Climatic cycling with condensation | |
| EN ISO 6988 | 6 cycles, storage 8/16h |
| Temperature cycling | |
| IEC 60068-2-14, Nb | 10 cycles, -40/+85°C (5°C/min) |
| Damp heat cyclic | |
| IEC 60068-2-30, Db, Variant 1 | 6 cycles, upper air temp. 55°C |
| Damp heat constant | |
| IEC 60068-2-3, Ca | 56 days |
| Category of environmental protection, | |
| IEC 61810 | RTI – dustproof |
| Degree of protection, IEC 60529 | IP54 (dustproof) |
| Corrosive gas | |
| IEC 60068-2-42 | 10±2cm ³ /m ³ SO ₂ , 10 days |
| IEC 60068-2-43 | 1±0.3cm ³ /m ³ H ₂ S, 10 days |
| Vibration resistance (functional) | |
| IEC 60068-2-6 (sine sweep) | 10 to 500Hz > 5g ⁹⁾ |
| Shock resistance (functional) | |
| IEC 60068-2-27 (half sine) | 11ms >20g ⁹⁾ |
| Drop test, free fall | |
| IEC 60068-2-32 | 1m onto concrete |
| Terminal type | plug-in, QC/PCB |
| Cover retention | |
| pull force | 150N |
| push force | 200N |
| Terminal retention | |
| pull force | 100N |
| push force | 100N |
| resistance to bending, force applied to front ¹⁰⁾ | 10N |
| resistance to bending, force applied to side ¹⁰⁾ | 10N |
| torque | 0.3Nm |
| Weight | approx. 35g (1.2oz) |
| Packaging unit | |
| plug-in/PCB | 315 pcs. |
| plug-in with bracket | 200 pcs. |
| 8) Refers to used materials. | |
| 9) No change in the switching state >10µs. Valid for NC contacts, NO contact values significantly higher. | |
| 10) Values apply 2mm from the end of the terminal. When the force is removed, the terminal must not have moved by more than 0.3mm. | |

Accessories

For details see datasheet Connectors for Mini ISO Relays

Power Relay F4 (Continued)

Terminal Assignment

NO
1 form A, 1 NO

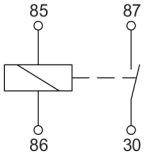

NOR
1 form A, 1 NO
with resistor

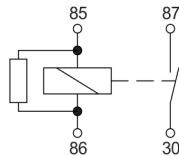

NOR_SD
1 form A, 1 NO
with resistor & serial diode

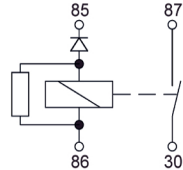

NO_2x87
1 form A, 1 NO (2x87)

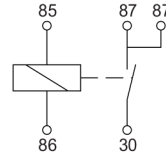

NOR_2x87
1 form A, 1 NO (2x87)
with resistor

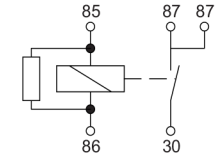

CO
1 form C, 1 CO

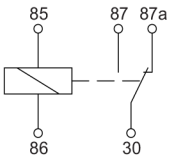

COR
1 form C, 1 CO
with resistor

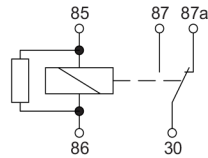

COD
1 form C, 1 CO
with diode

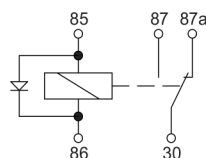

DNO
1 form U, 2 NO

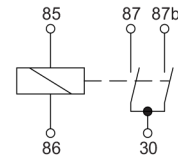

DNOR
1 form U, 2 NO
with resistor

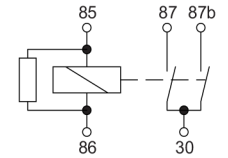

Dimensions

Power Relay F4 with quick connect (QC) terminals

View of the terminals (bottom view)

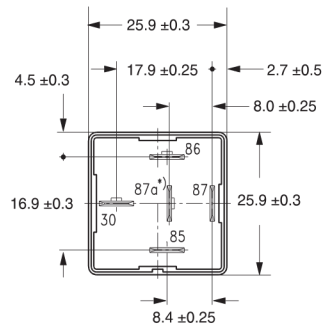
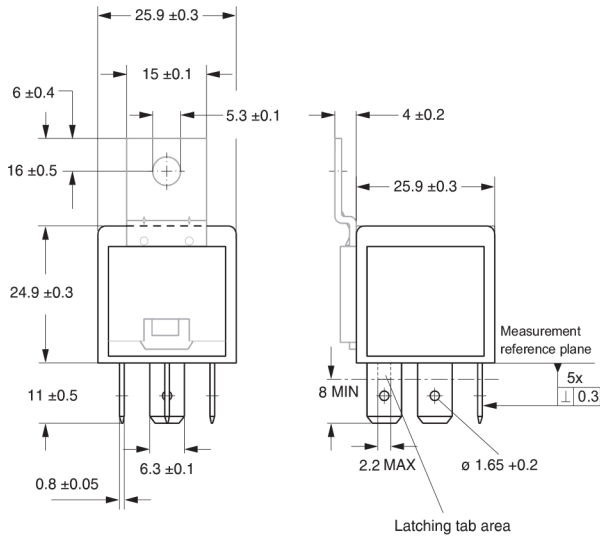

For the make contact (2x87), pin 87a = 87;
for the double make contact, pin 87a = 87b.

Quick connect terminal similar to ISO 8092-1

TE1093-S1

Power Relay F4 with PCB terminals

View of the terminals (bottom view)

Mounting hole layout (bottom view)

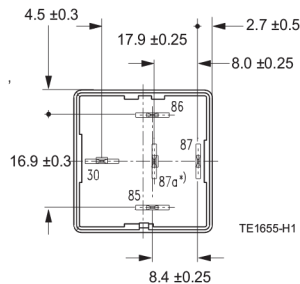
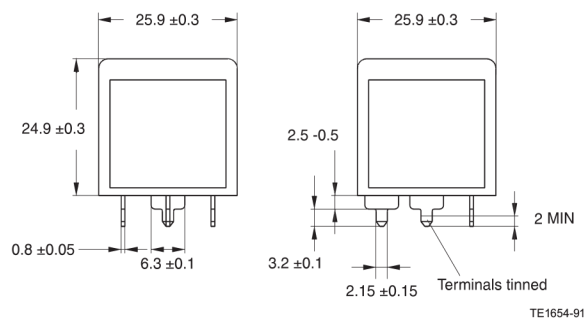

For the make contact (2x87), pin 87a = 87;
for the double make contact, pin 87a = 87b.

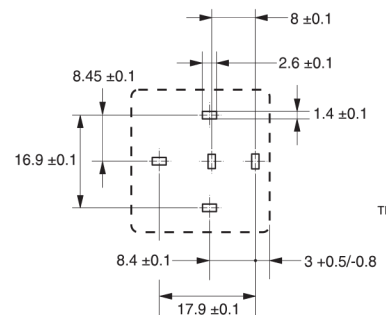

TE0907-B1

Power Relay F4 (Continued)

Product code structure

Typical product code **V23134 -A 0 052 -C643**

| | | | | |
|-----------------------------|--|---|--|--|
| Type | V23134 Power Relay F4 | | | |
| Contact arrangement | A 1 form C, 1 CO B 1 form A, 1 NO | C 1 form A, 1 NO (2x87) M 1 form U, 2 NO | | |
| Cover | 0 Standard 2 Bracket at terminal 86 ISO | 1 Bracket at terminal 30 ISO | | |
| Coil | 052 12VDC 056 24VDC (contact gap >0.8mm) | 053 24VDC 165 24VDC (contact gap >0.8mm) | | |
| Terminal/arrangement | C642 Plug-in/NO G242 PCB/NO Xnnn Customized (nnn: version number) | C643 Plug-in/CO G243 PCB/CO | | |

Production in Europe (only)

| Product code | Arrangement | Version | Coil suppr. | Circuit ¹⁾ | Coil | Contact mat. | Terminals | Part number |
|-----------------------------------|-----------------------|----------|----------------|-----------------------|-------|--------------|-------------|-------------|
| V23134-A0052-C643 | 1 form C, 1 CO | Standard | | CO | 12VDC | Silver based | Plug-in, QC | 2-1393302-2 |
| V23134-A0052-G243 | | | | | | | PCB | 2-1393302-3 |
| V23134-A0052-X278 | | | R 560Ω | COR | | | Plug-in, QC | 4-1393302-1 |
| V23134-A0053-C643 | | | | CO | 24VDC | | | 5-1393302-1 |
| V23134-A0053-G243 | | | | | | | PCB | 5-1393302-2 |
| V23134-A0056-X432 ²⁾ | | | D (cathode 86) | COD | | | Plug-in, QC | 1-1414167-0 |
| V23134-A0056-X433 ²⁾ | | | R 1200Ω | COR | | | | 1-1414168-0 |
| V23134-A1052-C643 | | Bracket | | CO | 12VDC | | | 5-1393302-8 |
| V23134-A1052-X294 ⁴⁾ | | | R 560Ω | COR | | | | 6-1393302-0 |
| V23134-A1053-C643 | | | | CO | 24VDC | | | 6-1393302-3 |
| V23134-A1053-X295 ⁴⁾ | | | R 1200Ω | COR | | | | 6-1393302-4 |
| V23134-B0052-C642 | 1 form A, 1 NO | Standard | | NO | 12VDC | | | 7-1393302-5 |
| V23134-B0052-G242 | | | | | | | PCB | 7-1393302-7 |
| V23134-B0052-X270 ⁶⁾ | | | R 680Ω | NOR | | | Plug-in, QC | 1-1414099-0 |
| V23134-B0052-X506 | | | R 560Ω | NOR_SD ⁵⁾ | | | | 4-1414992-3 |
| V23134-B0053-C642 | | | | NO | 24VDC | | | 1393303-9 |
| V23134-B0053-G242 | | | | | | | PCB | 1-1393303-0 |
| V23134-B1052-C642 | | Bracket | | | 12VDC | | Plug-in, QC | 3-1393303-4 |
| V23134-B1053-C642 | | | | | 24VDC | | | 3-1393303-7 |
| V23134-B1053-X296 ⁴⁾ | | | R 1200Ω | NOR | | | | 3-1393303-8 |
| V23134-C0052-C642 | 1 form A, 1 NO (2x87) | Standard | | NO_2x87 | 12VDC | | | 3-1393303-9 |
| V23134-C0053-C642 | | | | | 24VDC | | | 4-1393303-4 |
| V23134-C1052-C642 | | Bracket | | | 12VDC | | | 4-1393303-7 |
| V23134-C1052-X280 ⁴⁾⁵⁾ | | | R 560Ω | NOR_2x87 | | | | 4-1393303-8 |
| V23134-C1053-C642 | | | | NO_2x87 | 24VDC | | | 5-1393303-0 |
| V23134-M0052-C642 | 1 form U, 2 NO | Standard | | DNO | 12VDC | | Plug-in, QC | 5-1393304-6 |
| V23134-M0052-G242 | | | | | | | PCB | 5-1393304-7 |
| V23134-M0053-C642 | | | | | 24VDC | | Plug-in, QC | 6-1393304-7 |
| V23134-M0053-G242 | | | | | | | PCB | 6-1393304-8 |
| V23134-M0165-X539 ²⁾ | | | R 1200Ω | DNOR | | | Plug-in, QC | 3-1904117-6 |
| V23134-M1052-C642 | | Bracket | | DNO | 12VDC | | | 7-1393304-1 |
| V23134-M1053-C642 | | | | | 24VDC | | | 7-1393304-4 |

- 1) See terminal assignment diagrams. 4) No hole in terminal 30.
 2) Special feature: contact gap >0.8mm. 5) No hole in terminal 87a.
 3) Serial diode. 6) No holes in all terminals.

Other types on request.

This list represents the most common types and does not show all variants covered by this datasheet.

Production in Asia (only)

| Product code | Arrangement | Version | Coil suppr. | Circuit ¹⁾ | Coil | Contact mat. | Terminals | Part number |
|---------------------------------|----------------|----------|-------------|-----------------------|-------|--------------|-------------|-------------|
| V23134-B0052-C642 | 1 form A, 1 NO | Standard | | NO | 12VDC | Silver based | Plug-in, QC | 7-1904094-0 |
| V23134-B0052-X270 ²⁾ | | | R 680Ω | NOR | | | | 7-1904094-1 |
| V23134-B0053-C642 | | | | NO | 24VDC | | | 7-1904094-5 |

- 1) See terminal assignment diagrams.
 2) No holes in all terminals.

Other types on request.

This list represents the most common types and does not show all variants covered by this datasheet.